



KIFER
MEDICAL

CATALOGO

2017

• UROLOGY •

NP-6 URETHRO-CYSTOSCOPY SET (CLICK)

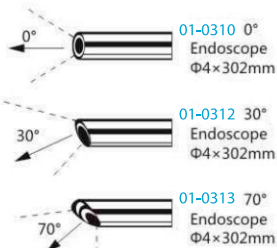

1. OLYMPUS
STORZ
2. WOLF
3. ACMI STRYKER

1. Connecting to TIANSONG light guide cable
Connecting to OLYMPUS light guide cable
Connecting to STORZ light guide cable
2. Connecting to WOLF light guide cable
3. Connecting to ACMI, STRYKER light guide cable

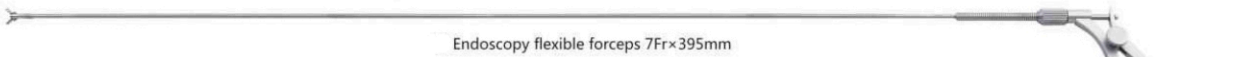
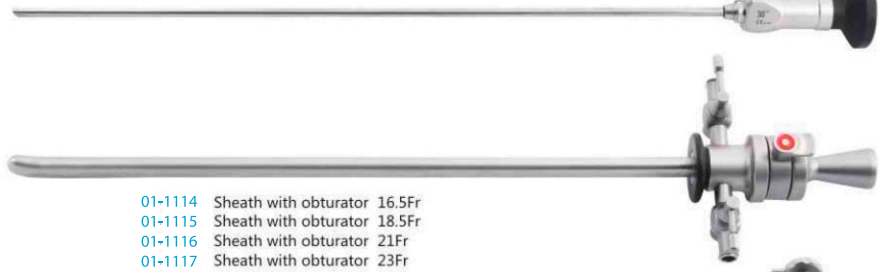

NP-7 URETHRO - CYSTOSCOPY SET (LOCKABLE)



01-0010 0°
Endoscope
Φ4×302mm

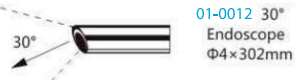

01-0012 30°
Endoscope
Φ4×302mm

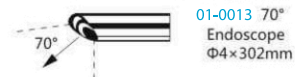

01-0013 70°
Endoscope
Φ4×302mm



21-1001 Adaptor



21-1009.1
Luer-lock adaptor



01-2145 sealing cap

1. OLYMPUS
STORZ
2. WOLF
3. ACMI STRYKER

1. Connecting to TIANSONG light guide cable
Connecting to OLYMPUS light guide cable
Connecting to STORZ light guide cable
2. Connecting to WOLF light guide cable
3. Connecting to ACMI, STRYKER light guide cable

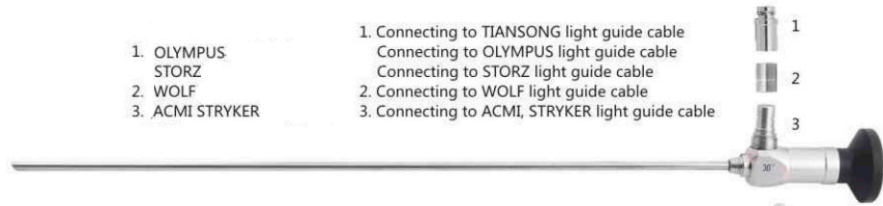

- 01-1101.1 Sheath with obturator 16.5Fr
- 01-1102.1 Sheath with obturator 18.5Fr
- 01-1103.1 Sheath with obturator 21Fr
- 01-1104.1 Sheath with obturator 23Fr

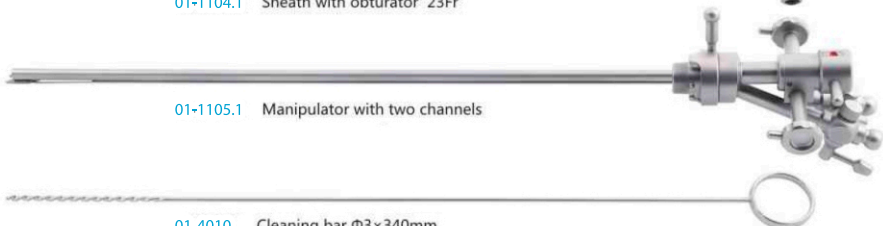

01-1105.1 Manipulator with two channels

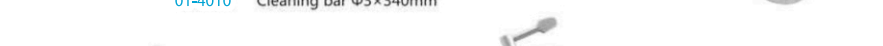

01-4010 Cleaning bar Φ3×340mm



20-5020.2
Light guide cable autoclavable
Ø 4.8 x 2500mm



01-1106.1
Endoscope bridge(single channel)



01-1106.2
Endoscope bridge(Double channel)



01-1106.3
Endoscope bridge(without valve)

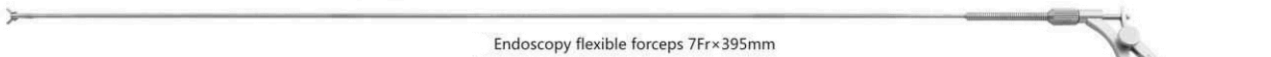

Endoscopy flexible forceps 7Fr×395mm



01-2101
Biopsy forceps



01-2102
Foreign body forceps



01-2103
Serrated forceps



01-2104
Scissors

NP-2 PEDIATRIC CYSTOSCOPY SET (LOCKEABLE)



1. OLYMPUS
STORZ
2. WOLF
3. ACMI STRYKER

1. Connecting to TIANSONG light guide cable
Connecting to OLYMPUS light guide cable
2. Connecting to WOLF light guide cable
3. Connecting to ACMI, STRYKER light guide cable

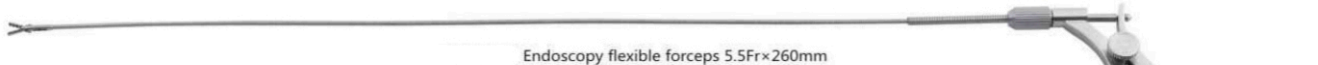
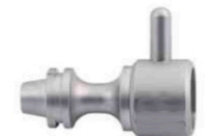
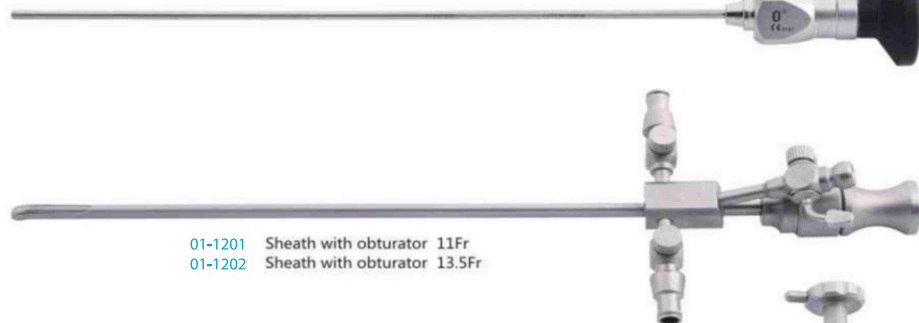

NQ-3 URETHROTOMY SET (LOCKEABLE)

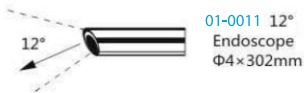

01-0011 12° Endoscope
Φ4×302mm

1. OLYMPUS
STORZ
2. WOLF
3. ACMI STRYKER

1. Connecting to TIANSONG light guide cable
Connecting to OLYMPUS light guide cable
2. Connecting to WOLF light guide cable
3. Connecting to ACMI, STRYKER light guide cable

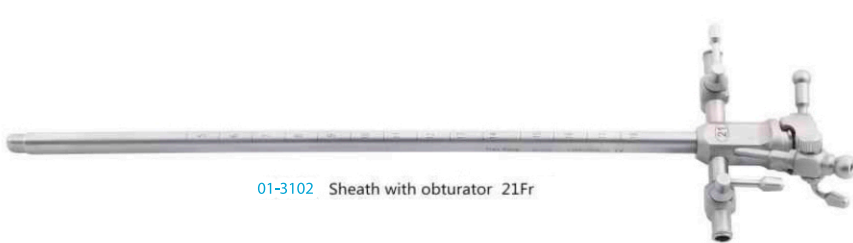

01-3102 Sheath with obturator 21Fr

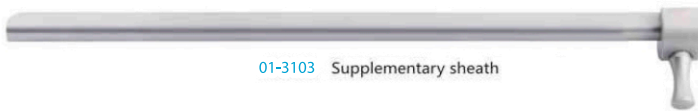

01-3103 Supplementary sheath



01-3101 Working element (passive)



Cold knife



01-3104 Lancet



01-3105 Half-round knife



01-3106 Hook shape knife



21-1001 Adaptor



21-1009.1
Luer-lock adaptor



01-2145 Sealing cap



20-5020.2
Light guide cable autoclavable
Ø 4.8 x 2500mm

DQ-4 RESECTOSCOPY SET (LOCKEABLE)



1. OLYMPUS
STORZ
2. WOLF
3. ACMI STRYKER

1. Connecting to TIANSONG light guide cable
Connecting to OLYMPUS light guide cable
Connecting to STORZ light guide cable
2. Connecting to WOLF light guide cable
3. Connecting to ACMI, STRYKER light guide cable



1.3 - DS - 24
Loop 30°



4 - DS - 24
Roller



5 - DS - 24
Spike



3.1 - DS - 24
Spud 30°



13 - 1015
High frequency cord (Monopolar)



21-4002
Evacuator(Ellik)
21-1001.6
Adaptor

DQ-7 RESECTOSCOPY SET (CLICK)



1. OLYMPUS
STORZ
2. WOLF
3. ACMI STRYKER

1. Connecting to TIANSONG light guide cable
Connecting to OLYMPUS light guide cable
2. Connecting to STORZ light guide cable
3. Connecting to WOLF light guide cable
3. Connecting to ACMI, STRYKER light guide cable

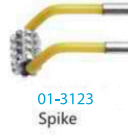
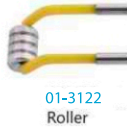
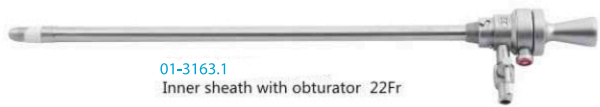

DQ-8 RESECTOSCOPY SET (CLICK)

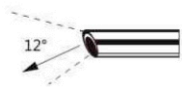

01-0011 12°
Endoscope
Φ4×302mm

1. OLYMPUS
STORZ
2. WOLF
3. ACMI STRYKER

1. Connecting to TIANSONG light guide cable
Connecting to OLYMPUS light guide cable
2. Connecting to WOLF light guide cable
3. Connecting to ACMI, STRYKER light guide cable

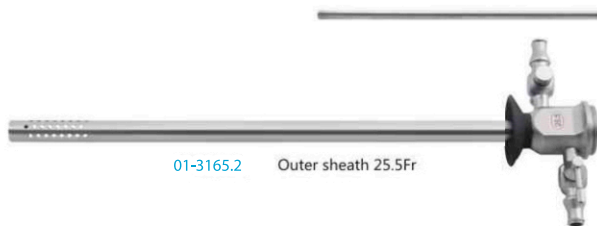

01-3165.2 Outer sheath 25.5Fr



01-3163.2
Inner sheath with obturator 22Fr



01-3162
Working element (Passive)



Electrode



01-3111
Loop



01-3112
Roller



01-3123
Spike



01-3124
Spud



13-1001
High frequency cord (Monopolar)



21-4002
Evacuator(Ellik)
T1001.5
Adaptor

DQ-10 RESECTOSCOPY SET (CLICK/BIPOLAR)



1. OLYMPUS
STORZ
2. WOLF
3. ACMI STRYKER

1. Connecting to TIANSONG light guide cable
Connecting to OLYMPUS light guide cable
2. Connecting to STORZ light guide cable
Connecting to WOLF light guide cable
3. Connecting to ACMI, STRYKER light guide cable

- 1
- 2
- 3

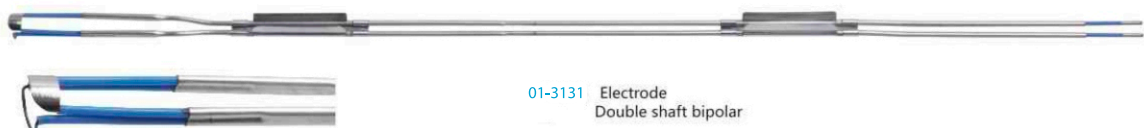
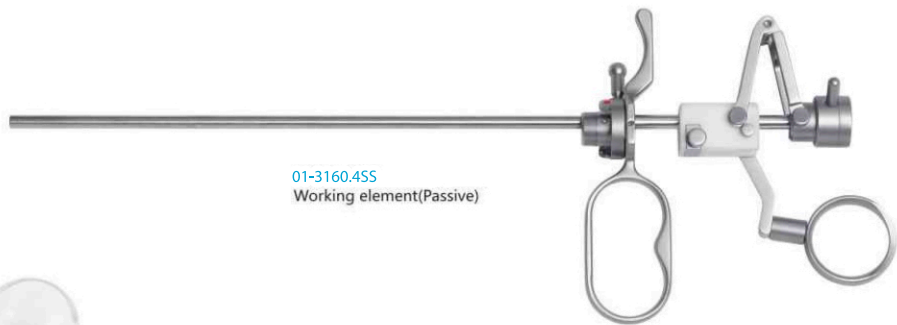
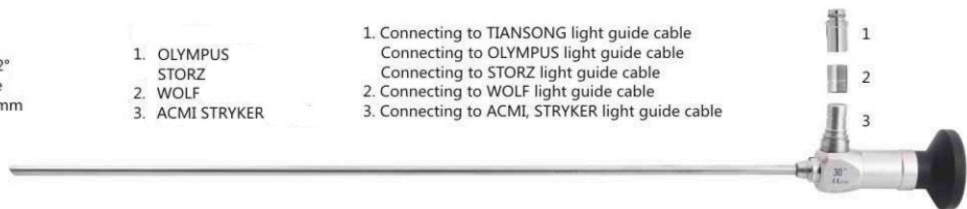

DQ-9 PEDIATRIC RESECTOSCOPY SET (LOCKABLE)



01-0210 0°
Endoscope
Φ2.7×205mm



21-4002
Evacuator(Elik)
T1001.10
Adaptor

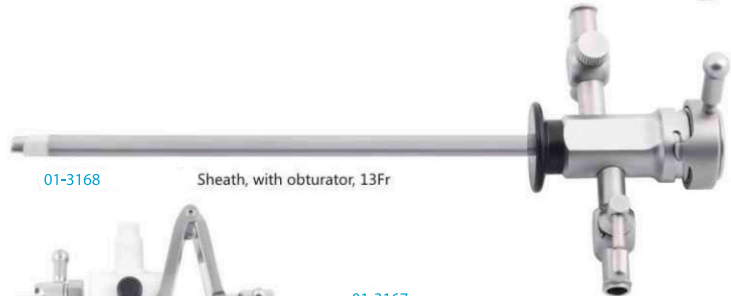

01-3168 Sheath, with obturator, 13Fr

01-3167
Working element(Passive)



13-1001
High frequency cord (Monopolar)



Electrode
01-3111.2 Loop

RESECTOSCOPE SET INTERCHANGEABLE PARTS



13-0015
H.F Generator (Multifunction)



20-5020.2
Light guide cable autoclavable
Ø 4.8 x 2500mm



21-1009.1
Luer-lock adaptor



21-1001 Adaptor

PS-3 LITHOTRIPTOSCOPY SET (CURVED HEAD)

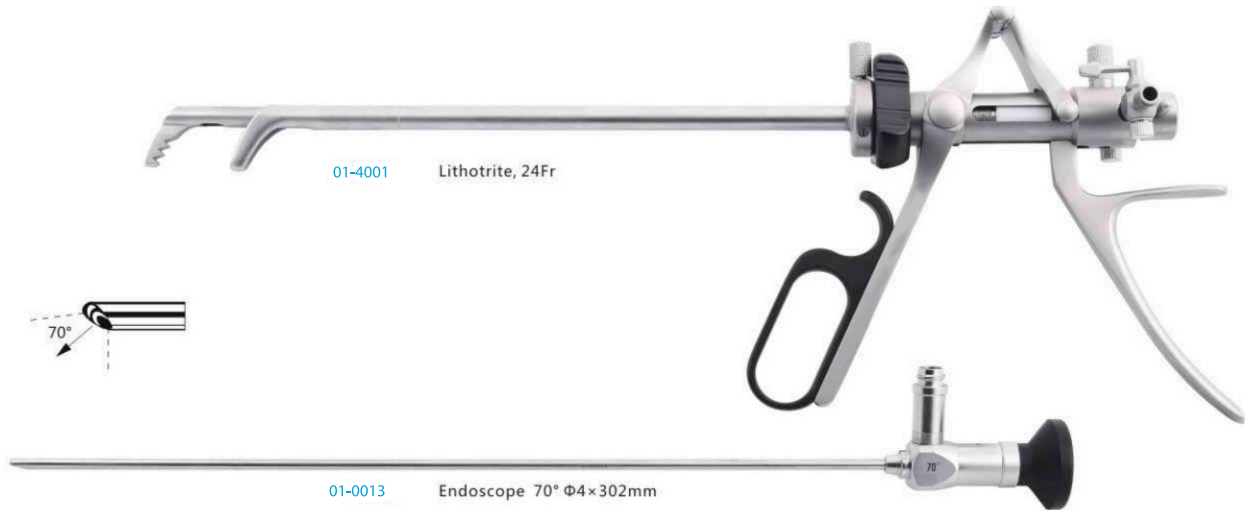

PS-4 LITHOTRIPTOSCOPY SET (STRAIGHT)



PS-3/PS-4 LITHOTRIPTOSCOPY INTERCHANGEABLE PARTS



SS-3 URETERORENOSCOPY SET

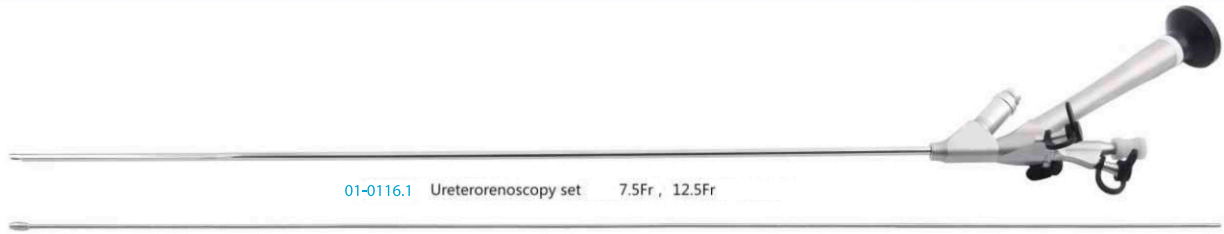

01-0116.1 Ureterorenoscopy set 7.5Fr, 12.5Fr



01-2112.1 Dilator 13 Fr
01-2112.2 Dilator 11 Fr
01-2112.3 Dilator 9 Fr



21-1009.1 Luer-lock adaptor



01-2145 sealing cap

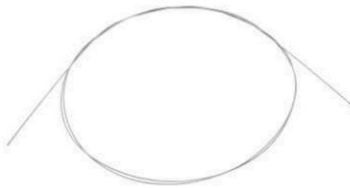

01-2001 Metal wire



20-5020.2 Light guide cable autoclavable
Ø 4.8 x 2500mm



01-2108.2 Grasping forceps, rigid
4.5 Fr x 600mm



01-2109.2 Biopsy forceps, rigid
4.5 Fr x 600mm



01-2110.2 Grasping forceps, flexible
4.5 Fr x 600mm



01-2111.2 Biopsy forceps, flexible
4.5 Fr x 600mm

URETERORENOSCOPY SET OPTIONS

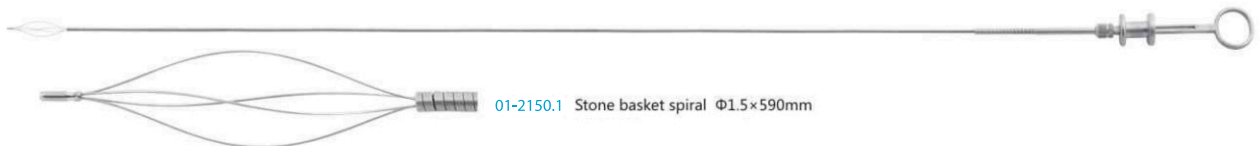

01-2150.1 Stone basket spiral Φ1.5 x 590mm



01-2108 5Fr x 600mm Grasping forceps, rigid
01-2108.3 4Fr x 600mm Grasping forceps, rigid



01-2109 5Fr x 600mm Biopsy forceps, rigid
01-2109.3 4Fr x 600mm Biopsy forceps, rigid



01-2110 5Fr x 600mm Grasping forceps, flexible
01-2110.3 4Fr x 600mm Grasping forceps, flexible



01-2111 5Fr x 600mm Biopsy forceps, flexible
01-2111.3 4Fr x 600mm Biopsy forceps, flexible

JP-1 PERCUTANEOUS NEPHROSCOPE SET



01-0118 Side-View endoscope 16Fr



01-3170.1 Sheath 19Fr



01-3174 Dilator 9-21Fr



01-3171 Trocar 4.5Fr



01-3175 Open conductor



01-3173 Dilator cannula 6Fr, 7.5Fr, 9Fr

01-3172 Guide Bar 9Fr



21-1009.1 Luer-lock adaptor

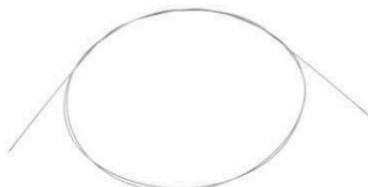

01-2001 Metal Wire



20-5020.2 Light guide cable autoclavable
Ø 4.8 x 2500mm



21-1001 Adaptor



01-2145 Sealing cap



01-2152 Serrated forceps
10.5 Fr x 350mm

01-2153 Grasping forceps
10.5 Fr x 350mm

01-2154 Three claws, grasping forceps
10.5 Fr x 350mm

01-2155 Foreign body forceps
10.5 Fr x 350mm

UROLOGY INSTRUMENTS OPTIONS



01-0010 0° Φ 4×302mm
01-0020 0° Φ 2.9×302mm
01-0210 0° Φ 2.7×205mm Pediatric
01-0220 0° Φ 2.9×302mm
 134°2bar Autoclave
01-0320 0° Φ 4×302mm Wide angle
 134°2bar Autoclave

01-0011 12° Φ 4×302mm
01-0041 12° Φ 4×302mm ACMI

01-0012 30° Φ 4×302mm
01-0022.1 30° Φ 3×302mm
01-0022.2 30° Φ 2.7×302mm
01-0211 30° Φ 2.7×205mm Pediatric
01-0042 30° Φ 4×302mm ACMI
01-0222 30° Φ 2.9×302mm
 134°2bar Autoclave
01-0322 30° Φ 4×302mm Wide angle
 134°2bar Autoclave

01-0013 70° Φ 4×302mm
01-0023.1 70° Φ 3×304mm
01-0323 70° Φ 4×304mm Wide angle
 134°2bar Autoclave

01-3160.3S 30°
 Working element, Active, for model 4 resectoscopy set

01-3161 12°
 Working element, Active, for model 8 resectoscopy set

Optical forceps (Lockable)

01-2100 0°
 Optical punch forceps,
 used with 0°endoscope

01-2106 30°
 Optical biopsy forceps,
 used with 30°endoscope

01-2105 0°
 Optical grasping forceps,
 used with 0°endoscope

01-2107 0°
 Optical scissors,
 used with 0°endoscope

optical forceps (Click)

01-2105.1 0°
 Optical grasping forceps,
 used with 0°endoscope

01-2106.1 30°
 Optical biopsy forceps,
 used with 30°endoscope

01-2107.1 0°
 Optical scissors,
 used with 0°endoscope

UROLOGY INSTRUMENTS OPTIONS



Male urethral dilator 8Fr-30Fr

01-2113 8Fr	01-2113.8 16Fr	01-2113.16 24Fr
01-2113.1 9Fr	01-2113.9 17Fr	01-2113.17 25Fr
01-2113.2 10Fr	01-2113.10 18Fr	01-2113.18 26Fr
01-2113.3 11Fr	01-2113.11 19Fr	01-2113.19 27Fr
01-2113.4 12Fr	01-2113.12 20Fr	01-2113.20 28Fr
01-2113.5 13Fr	01-2113.13 21Fr	01-2113.21 29Fr
01-2113.6 14Fr	01-2113.14 22Fr	01-2113.22 30Fr
01-2113.7 15Fr	01-2113.15 23Fr	



01-2130 Penis clamps



Female urethral dilator 18Fr-42Fr

01-2114.1 18Fr	01-2114.4 27Fr	01-2114.7 36Fr
01-2114.2 21Fr	01-2114.5 30Fr	01-2114.8 39Fr
01-2114.3 24Fr	01-2114.6 33Fr	01-2114.9 42Fr



Bladder trocar
01-2131.1a 1x5 20Fr
01-2131.1b 1x5 16Fr
01-2131.1c 1x5 18Fr
01-2131.1d 1x5 22Fr



01-2116.1 Φ 18-38mm
Urethral filar sound dilator (with knife)



Fistula needle
01-2131.2 20Fr
01-2131.3 18Fr
01-2131.4 22Fr
01-2131.5 16Fr
01-2131.6 24Fr

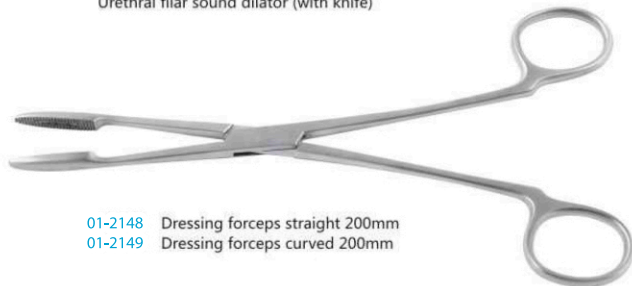

01-2148 Dressing forceps straight 200mm
01-2149 Dressing forceps curved 200mm



01-2101.1
Biopsy forceps, rigid
7Frx395mm

01-2102.1
Foreign body forceps, rigid
7Frx395mm

01-2103.1
Serrated forceps, rigid
7Frx395mm



21-1001.1 6, 7
Adaptor for model 6, 7 resectoscopy set
21-1001.5 8
Adaptor for model 8 resectoscopy set

21-1001.2
Adaptor for lithotrite

21-1001.3
Adaptor for veress needle

21-1001.4
WOLF
Adaptor for WOLF cystoscope

21-1001.6
STORZ
Adaptor for STORZ resectoscopy set

21-1009.2
Adaptor

ELECTRODE, DOUBLE SHAFT MONOPOLAR



01-3127 straight loop



01-3129 roller



01-3128 loop



01-3130 spud

ELECTRODE

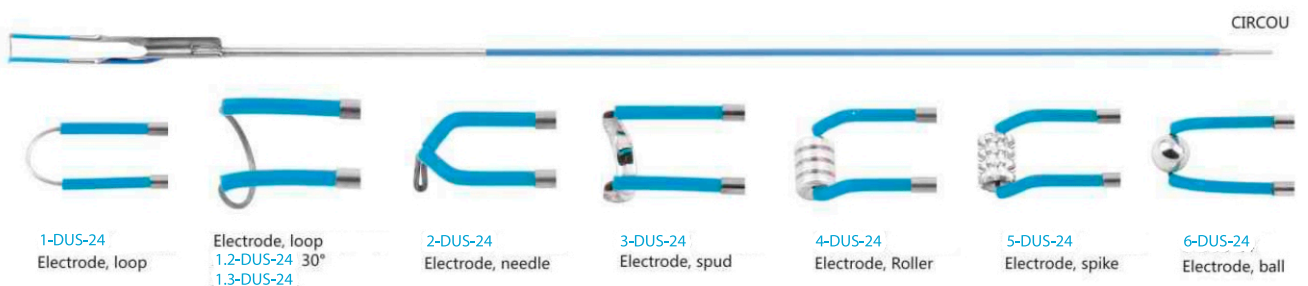
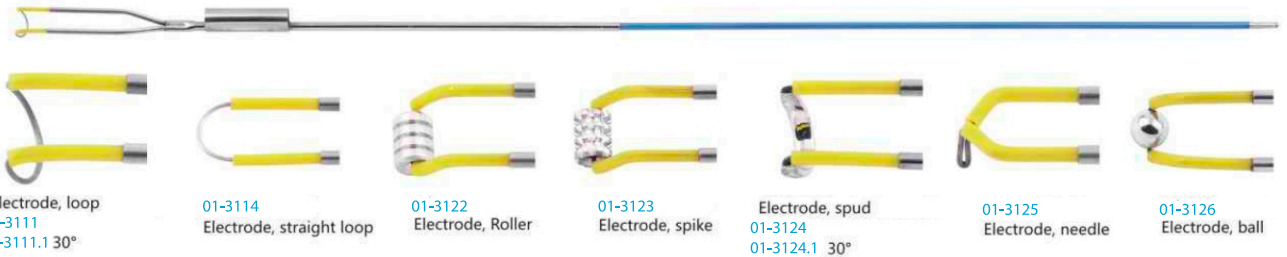

CAMERA SYSTEM



01-2500.06 Full HD Camera system (1920x1080)
USB flash disk support for storage Full HD video and images



01-2500.04 Single Chip Camera System with USB
System for video and images.

COUPLER

Coupler, Straight



	Focal length
01-2513.1	F18
01-2512.3	F22
01-2513.3	F25
01-2512.1	F27
01-2517	F28
01-2512.5	F32
01-2512.6	F35

COLD LIGHT SOURCE



21-5040.1H LED



21-5007.6
Portable cold light source (with charger)

LIGHT GUIDE CABLE DIAGRAM

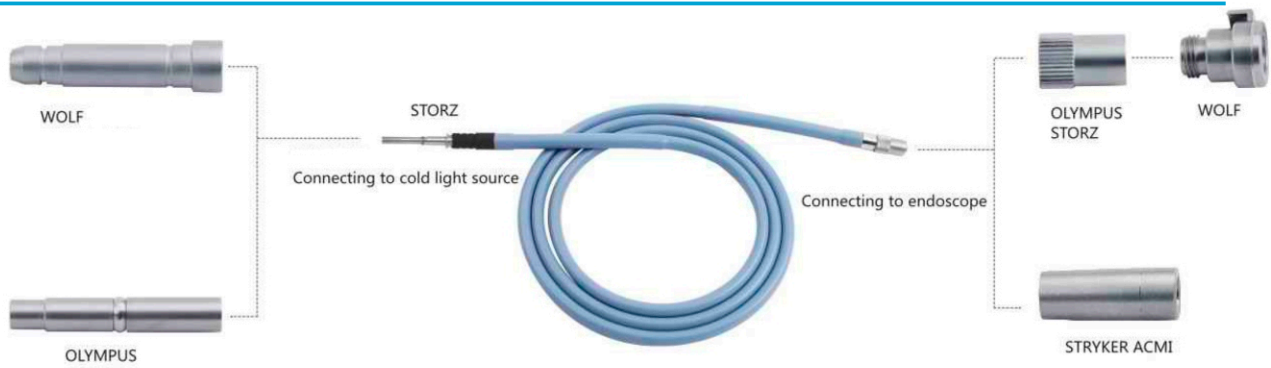

21-5010	Φ4.5×2000mm
21-5010.1	Φ4.5×1800mm
21-5010.2	Φ4.5×2000mm Autoclave
21-5010.3	Φ4.5×2000mm plasma
21-5012	Φ4.5×1800mm
21-5013	Φ1.8×1700mm
21-5014	Φ2.5×1700mm
21-5016.1	Φ1.8-Φ2.5 double head
21-5017	Φ2.5 double head
21-5018.2	Φ4.5×2300mm, plasma
21-5018	Φ4.5×2300mm
21-5018.1	Φ4.5×2300mm Autoclave
21-5020	Φ4.5×2500mm
21-5020.2	Φ4.5×2500mm Autoclave
21-5020.3	Φ4.5×2500mm, plasma

21-5021	Φ4.5×3000mm
21-5021.1	Φ4.5×3500mm
21-5021.2	Φ4.5×3500mm Autoclave
21-5021.3	Φ4.5×3000mm, plasma
21-5022	Φ5×2500mm
21-5023	Φ5×3000mm
21-5023.1	Φ5×3000mm Autoclave
21-5023.3	Φ4.5×3000mm, plasma
21-5023.5	Φ5×3000mm, plasma
21-5024	Φ5×3000mm OLYMPUS
21-5024.1	Φ5×3000mm OLYMPUS Autoclave
21-5024.2	Φ5×3000mm OLYMPUS, plasma

ADAPTOR



MEDICAL INSTRUMENTS STERILIZING BOX



01-0000.1
For Cystoscopy set
530×230×90mm

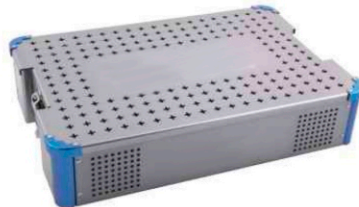

01-0000.2
For Resectoscope set
420×275×90mm



02-0000.3
For Sinuscopy instruments
380×210×70mm

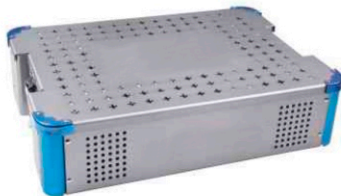

02-0000.2
For Sinuscopy set
360×255×90mm



06-0000
For electric hystera-cutter
560×275×140mm



190001000
Endoscope Instruments in common use
550×245×70mm



01-0000.5
Sterilizing box for Ureterorenoscopy
720×120×70mm



01-0000.7
For Cystoscopy set
390×80×52mm, nets



06-0000.1
Sterilizing box for Uterine manipulator
500×180×70mm, nets



06-0000.2
Sterilizing box for Hysteroscopy
720×120×55mm, nets



05-0000.3
Sterilizing box for Laparoscopy
460×80×52mm, nets



05-0000.4
reticular sterilizing box
100×100×55mm, nets



190001000a
Endoscope Instruments in common use
550×245×70mm



02-0000
For endoscope
280×70×50mm



02-0000.5
For endoscope, autoclavable
255×71×36mm



05-0000
For laparoscope
450×90×45mm



02-0000.4
For endoscope
255×71×36mm



01-0000.4
For endoscope, autoclavable
390×71×36mm