



KIFER
MEDICAL

CATALOGO

2017

E.N.T.



26-2001.6
Needle holder, straight with lock



26-2006 10cm
Scissor for eyes, Curved, Sharp head



26-2005 10cm
Scissor for eyes straight, Sharp head



Scissor, straight, sharp head
26-2007.1 lenght 14cm
26-2007.2 lenght 16cm
26-2007.3 lenght 18cm



26-2007.23
14cm
Tissue scissor, straight, half round



Tissue forceps Elis head
26-2008.1 width 5mm , lenght 14cm
26-2008.2 width 5mm , lenght 16cm
26-2008.3 width 5mm , lenght 18cm



Hemostatic forceps, curved, full tooth
26-2011.1 lenght 12.5cm
26-2011.2 lenght 14cm
26-2011.3 lenght 16cm
26-2011.4 lenght 18cm
26-2011.5 lenght 20cm
26-2011.6 lenght 22cm



Sponge forceps, curved, toothed
26-2016.4 8mm , 25cm
26-2016.6 12mm , 25cm



Alloy needle holder
26-2003.6 14cm Straight, gold-plating
26-2003.7 15cm Straight, gold-plating



Tissue scissor Straight, blunt head
26-2007.10 lenght 20cm
26-2007.11 lenght 19cm
26-2007.12 lenght 17cm
26-2007.13 lenght 14cm



Tissue scissor, curved, half round
26-2007.28 lenght 14cm
26-2007.30 lenght 17cm



Hemostatic forceps ,
straight, full tooth
26-2010.1 lenght 12.5cm
26-2010.2 lenght 14cm
26-2010.3 lenght 16cm
26-2010.4 lenght 18cm
26-2010.5 lenght 20cm
26-2010.6 lenght 22cm



Towel forceps, Sharp head
26-2013.1 lenght 11cm
26-2013.2 lenght 14cm
26-2013.3 lenght 16cm



03-2100
Fascia presser



26-2001 Micro needle holder forceps



Needle holder
26-2003.1 14cm Serration
26-2003.2 16cm Serration
26-2003.3 18cm Serration



26-2020.1 125mm Tweezers, Straight
26-2020.5 125mm Tweezers, Straight with hook



Tweezers
03-2049 160mm
03-2049.1 200mm
03-2049.2 160mm head with hook
03-2049.3 195mm head with hook
03-2049.4 180mm head with hook
03-2049.6 180mm



Tweezers
03-2050 110mm
03-2050.1 110mm head with hook

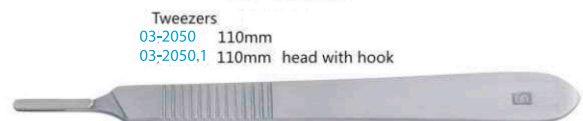

26-3001.1 12.5cm
Handle

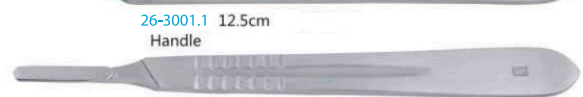

26-3001.4 13.5cm
Handle (with L blade)

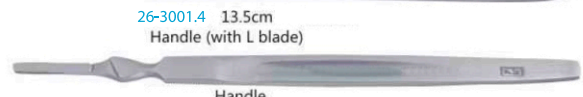

Handle
26-3001.7 12.5cm
26-3001.8 16.5cm



Tuning forks
03-2036.1 128
03-2036.2 256



Tuning forks
03-2036.3 512 03-2036.4 1024
03-2036.5 2048 03-2036.6 4096

03-1001.1
Ear speculum
Φ3, Φ4, Φ5
3pcs/set



03-1001.2
Ear speculum
Φ3, Φ4, Φ5
3pcs/set

02-3102.2
Foot pedal, programmable

02-3101.2
Control unit with pump

03-3201.2
Otology handpiece motor without brush



Straight joint
03-3202 70mm
03-3202.1 90mm
03-3202.2 125mm



Curved joint
03-3203 70mm
03-3203.1 90mm
03-3203.2 125mm



Standard straight shaft burrs

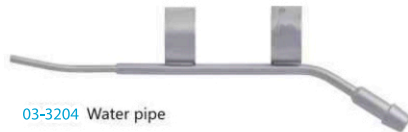

03-3204 Water pipe



03-3306 $\Phi 2 \times 70\text{mm}$ 03-3307 $\Phi 3 \times 70\text{mm}$ 03-3308 $\Phi 4 \times 70\text{mm}$ 03-3309 $\Phi 5 \times 70\text{mm}$ 03-3310 $\Phi 6 \times 70\text{mm}$

WZ-4 SHAVER SYSTEM

03-3404 Control unit

03-3405 Foot pedal

03-3401
Otology handpiece motor without brush



Straight joint

03-3302 70mm
03-3302.1 90mm
03-3302.2 125mm



Curved joint



03-3303 70mm
03-3303.1 90mm
03-3303.2 125mm



Standard straight shaft burrs

03-3306 $\Phi 2 \times 70\text{mm}$ 03-3307 $\Phi 3 \times 70\text{mm}$ 03-3308 $\Phi 4 \times 70\text{mm}$ 03-3309 $\Phi 5 \times 70\text{mm}$ 03-3310 $\Phi 6 \times 70\text{mm}$

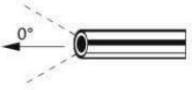
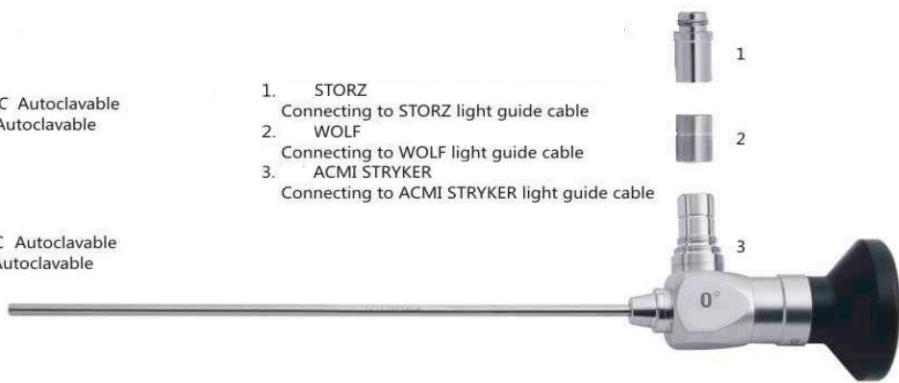
OTOSCOPE

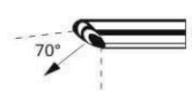
	<p>03-0010 0° Φ2.7×105mm 03-0010.1b 0° Φ3×90mm 03-0010.1c 0° Φ3.3×90mm(Wireless) 03-0020 0° Φ2.7×55mm 03-0030 0° Φ4×45mm 03-0010.1 0° Φ2.7×107mm 2bar 134°C Autoclavable 03-0030.1 0° Φ4×45mm 2bar 134°C Autoclavable</p>	<p>1. STORZ Connecting to STORZ light guide cable 2. WOLF Connecting to WOLF light guide cable 3. ACMI STRYKER Connecting to ACMI STRYKER light guide cable</p> 
	<p>03-0012 30° Φ2.7×105mm 03-0022 30° Φ2.7×55mm 03-0032 30° Φ4×45mm 03-0012.1 30° Φ2.7×107mm 2bar 134°C Autoclavable 03-0032.1 30° Φ4×45mm 2bar 134°C Autoclavable</p>	
	<p>03-0013 70° Φ2.7×105mm 03-0023 70° Φ2.7×55mm 03-0033 70° Φ4×45mm 03-0013.1 70° Φ2.7×107mm 2bar 134°C Autoclavable 03-0033.1 70° Φ4×45mm 2bar 134°C Autoclavable</p>	

MIDDLE EAR FORCEPS 70mm



			
03-2001 (5mm) Punch head (head length 5mm)	03-2002 (5mm) Ring head (head length 5mm)	Triticeous head 03-2003.1 (5mm) Large (head length 5mm) 03-2003.2 (3.5mm) Small (head length 3.5mm) 03-2003.3 upward 30° 03-2003.4 head length 11mm	
			
03-2004 (5mm) 45° Cup head (head length 5mm)	03-2004.2 45° Cup head, right-curved	Cup head 03-2005.1 (5mm) Large (head length 5mm) 03-2005.2 (4mm) Small (head length 4mm)	
			
03-2006 (4mm) Polyp scissors, straight (head length 4mm)	Polyp scissors 03-2006.1 (4mm) left curved (head length 4mm) 03-2006.2 (4mm) right curved (head length 4mm)	03-2013 (5mm) Stapes install forceps (head length 5mm)	
			
Malleus arch scissors 03-2014 left upward 03-2015 right upward	03-2060 (80mm) Malleus rongeur scissors	03-2061 (110mm) Malleus rongeur scissors	
			
03-2066 (3.5mm) Olive head (head length 5mm)	03-2067 (3.5mm) Straight bowl (head length 3.5mm)	03-2068 (3.5mm) Triticeous head (head length 3.5mm)	03-2069 (3.5mm) Straight scissors (head length 3.5mm)

OTOSCOPY INSTRUMENTS



Curette, straight and blunt mouth
03-2016.1 Φ4mm
03-2016.2 Φ3mm
03-2016.3 Φ2mm



Curette, curved and blunt mouth
03-2017.1 Φ4mm
03-2017.2 Φ3mm
03-2017.3 Φ2mm



Curette, straight and sharp mouth
03-2018.1 Φ4mm
03-2018.2 Φ3mm
03-2018.3 Φ2mm



Curette, curved and sharp mouth
03-2019.1 Φ4mm
03-2019.2 Φ3mm
03-2019.3 Φ2mm



03-2058 (2.5mm)
Auditory lamellate knife
straight 160mm(head width 2.5mm)



03-2059.1 45°
Auditory lamellate knife
angled 2.5mm, 160mm



03-2059.2 45°
Auditory lamellate knife
angled 2mm, 160mm



Micro ear hook(160mm)
03-2062.1 0.3mm
03-2062.2 0.6mm
03-2062.3 1mm



03-2064 (160mm)
Micro ear needle, straight
03-2052 Cerumen hook
curved



03-2065 (45°)
Micro ear needle, curved
03-2079 Cerumen hook
45° head curved



Periosteotome, half-moon blade
03-2040 Bayonet shaped
03-2042 Angle shaped



Periosteotome, triangular blade
03-2041 Bayonet shaped
03-2043 Angle shaped



03-2053 Cerumen hook
curved



Cerumen hook, bayonet shaped
03-2051.1 2mm blade width 2mm
03-2051.2 4mm blade width 4mm



03-2080 Micro cerumen hook, 9pcs



03-2074 Micro cerumen hook, 21pcs

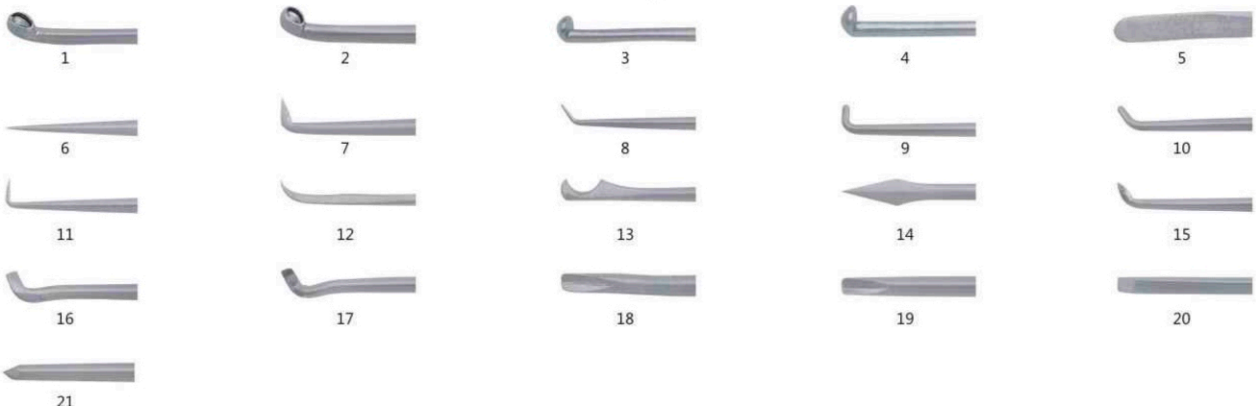

OTOSCOPY INSTRUMENTS



03-2056 Headlight



03-2056.3 LED Headlight LED high brightness, with charger



03-2056.2 Light guide cable for headlight $\Phi 3 \times 2500\text{mm}$



Charger

Standard straight shaft burs

- 03-3306.1 $\Phi 2 \times 90\text{mm}$ 03-3306.2 $\Phi 2 \times 125\text{mm}$ 03-3320 $\Phi 1.5 \times 70\text{mm}$
- 03-3307.1 $\Phi 3 \times 90\text{mm}$ 03-3307.2 $\Phi 3 \times 125\text{mm}$ 03-3321 $\Phi 2.5 \times 70\text{mm}$
- 03-3308.1 $\Phi 4 \times 90\text{mm}$ 03-3308.2 $\Phi 4 \times 125\text{mm}$ 03-3322 $\Phi 3.5 \times 70\text{mm}$
- 03-3309.1 $\Phi 5 \times 90\text{mm}$ 03-3309.2 $\Phi 5 \times 125\text{mm}$ 03-3323 $\Phi 4.5 \times 70\text{mm}$
- 03-3310.1 $\Phi 6 \times 90\text{mm}$ 03-3310.2 $\Phi 6 \times 125\text{mm}$

Diamond straight shaft burs

- 03-3311 $\Phi 2 \times 70\text{mm}$ 03-3311.1 $\Phi 2 \times 90\text{mm}$ 03-3329 $\Phi 1.4 \times 70\text{mm}$
- 03-3312 $\Phi 3 \times 70\text{mm}$ 03-3312.1 $\Phi 3 \times 90\text{mm}$ 03-3330 $\Phi 2.7 \times 70\text{mm}$
- 03-3313 $\Phi 4 \times 70\text{mm}$ 03-3313.1 $\Phi 4 \times 90\text{mm}$ 03-3331 $\Phi 3.5 \times 70\text{mm}$
- 03-3314 $\Phi 5 \times 70\text{mm}$ 03-3314.1 $\Phi 5 \times 90\text{mm}$ 03-3332 $\Phi 4.5 \times 70\text{mm}$
- 03-3315 $\Phi 6 \times 70\text{mm}$ 03-3315.1 $\Phi 6 \times 90\text{mm}$



03-1001 Otoscopy sheath



03-2077 Suction head $\Phi 1.5 \times 30\text{mm}$



03-2055 Cotton applicator



03-2055.1 Cotton applicator, spring handle



Spiral head



Triangular head



Spiral head



Triangular head



- Suction tube, upward
- 03-2081 $\Phi 2 \times 110\text{mm}$
 - 03-2082 $\Phi 1.5 \times 110\text{mm}$
 - 03-2083 $\Phi 1 \times 110\text{mm}$

- Suction tube, downward
- 03-2081.1 $\Phi 2 \times 110\text{mm}$
 - 03-2082.1 $\Phi 1.5 \times 110\text{mm}$
 - 03-2083.1 $\Phi 1 \times 110\text{mm}$

- Suction tube, curved
- 03-2078.1 $\Phi 4 \times 80\text{mm}$
 - 03-2078.2 $\Phi 3 \times 80\text{mm}$
 - 03-2078.3 $\Phi 2.5 \times 80\text{mm}$
 - 03-2078.4 $\Phi 2 \times 80\text{mm}$



03-2047 Probe Bayonet shaped $\Phi 2.5\text{mm}$

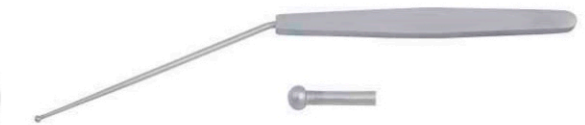

03-2048 Probe Knee shaped $\Phi 2\text{mm}$

OTOSCOPY INSTRUMENTS



Plester self retaining retractors
03-2038 130mm
03-2038.1 Single tooth



Backman laminectomy retractors 160mm
03-2039



Plester self retaining retractors
03-2038.2 2x2
03-2038.3 2x2



Backman laminectomy retractors 160mm
03-2039.1

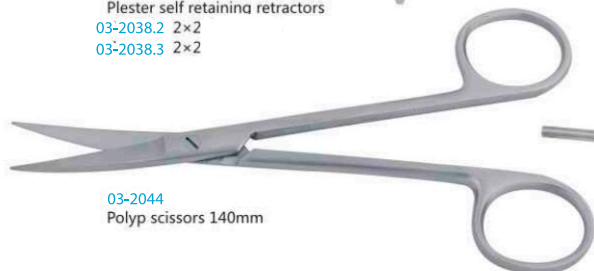

03-2044
Polyp scissors 140mm



03-2045 Polyp snare



Micro ear curette
03-2070.1 Φ 2mm
double heads, large
03-2070.2 Φ 1.5mm
double heads, small



03-2071 Φ 2mm
Micro ear curette, Only head



03-2075 Φ 2x90mm
Suction tube, micro curved



03-2076 Φ 2x90mm Suction tube, straight



Mastoid suction tube 105mm
03-2035.1 Φ 3mm 03-2035.2 Φ 4mm 03-2035.3 Φ 5mm



Suction tube 125mm
03-2046.1 Φ 4mm 03-2046.2 Φ 3mm 03-2046.3 Φ 2.5mm
03-2046.9 Φ 3.5mm
03-2046.10 Φ 2x125mm straight



Suction tube 85mm
03-2046.4 Φ 1mm 03-2046.5 Φ 1.5mm
03-2046.6 Φ 2mm 03-2046.7 Φ 2.5mm
03-2046.8 Φ 3mm



Mastoid curette, 160mm
03-2022 Φ 1.5mm 03-2023 Φ 2.0mm 03-2024 Φ 2.5mm
03-2025 Φ 3.0mm 03-2026 Φ 3.5mm 03-2027 Φ 4.0mm
03-2028 Φ 4.5mm 03-2029 Φ 5.0mm 03-2030 Φ 5.5mm
03-2031 Φ 6.0mm

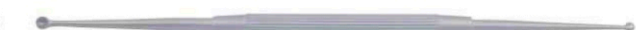

03-2026.1 Φ 3mm & Φ 4mm
Mastoid curette, round bowl, double heads



Mastoid mallet
03-2034.1 Φ 19x60mm 03-2034.2 Φ 17x55mm
03-2034.3 Φ 15x50mm



03-2034.4
Mastoid mallet, rubber





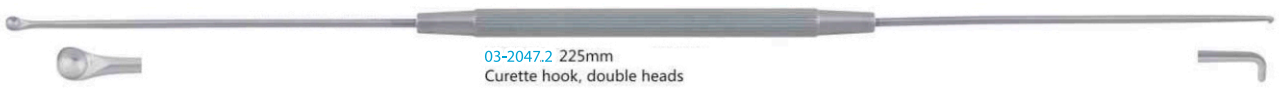
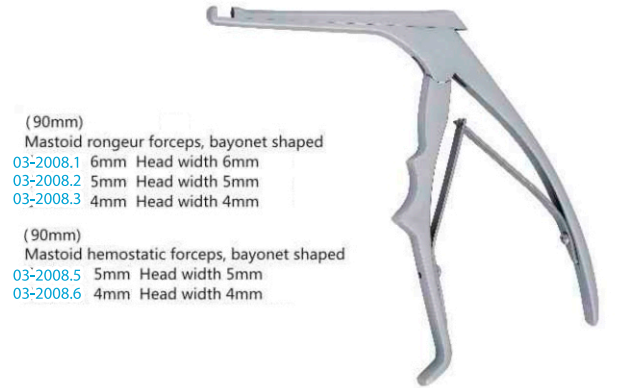

03-2034.7
Mastoid mallet, rubber with needle



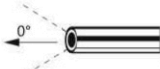
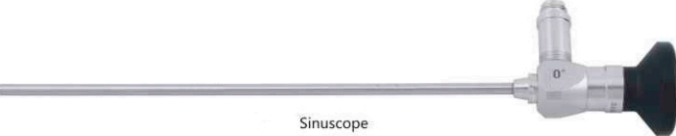







OTOSCOPY INSTRUMENTS



SINUSCOPE

 <p>02-0110 0° Φ4×175mm, Wide angle 02-0210 0° Φ2.7×175mm, Pediatric 02-0310 0° Φ2.7×175mm, 134°C2bar wide angle autoclavable 02-0120 0° Φ4×175mm, 134°C2bar wide angle autoclavable</p>	 <p>Sinuscope</p>
 <p>02-0112 30° Φ4×175mm, Wide angle 02-0212 30° Φ2.7×175mm, Pediatric 02-0312 30° Φ2.7×175mm, 134°C2bar wide angle autoclavable 02-0122 30° Φ4×175mm, 134°C2bar wide angle autoclavable</p>	
 <p>02-0016 45° Φ4×175mm 02-0016.1 45° Φ4×175mm, 134°C2bar wide angle autoclavable</p>	
 <p>02-0113 70° Φ4×175mm, Wide angle 02-0213 70° Φ2.7×175mm, Pediatric 02-0123 70° Φ4×175mm, 134°C2bar wide angle autoclavable</p>	
	 <p>Sinuscope 02-0040 0° Φ4×175mm 02-0042 30° Φ4×175mm 02-0043 70° Φ4×175mm 02-0044 45° Φ4×175mm</p>

NASAL OPERATING FORCEPS

 <p>Nasal tissue forceps 02-2007.1 left-curved(Large) 02-2007.2 left-curved(Small) 02-2008.1 right-curved(Large) 02-2008.2 right-curved(Small)</p>	 <p>02-2019 Nasal biopsy forceps, straight Φ3.5×110mm</p>	 <p>0°145mm Nasal tissue forceps 02-2109 Open to left 02-2110 Open to right</p>		
 <p>02-2028 110mm Nasal foreign body forceps, without hook</p>	 <p>02-2029 110mm Nasal foreign body forceps, with hook</p>			
 <p>02-2020 Φ3.5×110mm Nasal biopsy forceps</p>	 <p>02-2021 Φ3.5×110mm Nasal biopsy forceps, curved</p>	 <p>Nasal grasping forceps 105mm 02-2043 90°/ 120° downward 90°, open to back 120° 02-2043.2 90°/ 120° Upward 90°, open to back 120°</p>	 <p>Nasal grasping forceps 105mm 02-2043.1 115° Long curved, downward 115° 02-2043.3 115° Long curved, upward 115°</p>	 <p>Nasal grasping forceps 02-2043.4 80°curved,downward 80° 02-2043.5 80° Long curved, downward 80° 02-2043.6 90°/ 120° Downward 90°,back open 120°</p>

NASAL OPERATING FORCEPS





 <p>(0°/105mm) Nasal tissue forceps,without fixed pin 02-2517.1 Large 02-2517.2 Middle 02-2517.3 Small 02-2517.4</p>	 <p>(45°/105mm) Nasal tissue forceps,without fixed pin 02-2519.1 Large 02-2519.2 Small</p>	 <p>02-9100 (0°/105mm) Tissue forceps of nasal cavity sharp head, without fixed pin</p>			
 <p>02-9101 (30°/105mm) Tissue forceps of nasal cavity sharp head, without fixed pin</p>	 <p>02-9102 (45°/105mm) Tissue forceps of nasal cavity sharp head, without fixed pin</p>	 <p>02-9103 (90°/105mm) Tissue forceps of nasal cavity sharp head, without fixed pin</p>			
 <p>02-9104 (0°/105mm) Tissue forceps of nasal cavity round head, without fixed pin</p>	 <p>02-2022 (130mm) Nasal polyp ethmoid forceps Round head</p>	 <p>02-2023 (130mm) Nasal polyp ethmoid forceps Sharp head</p>	 <p>(105mm) 0° Tissue forceps of nasal cavity with suction tube 02-2039 (L) 02-2039.1 (M)</p>	 <p>(105mm) 30° Tissue forceps of nasal cavity with suction tube 02-2040 (L) 02-2040.1 (M)</p>	
 <p>(105mm) 45° Tissue forceps of nasal cavity with suction tube 02-2041 (L) 02-2041.1 (M)</p>	 <p>(105mm) 90° Tissue forceps of nasal cavity with suction tube 02-2042 (L) 02-2042.1 (M)</p>	 <p>(0°/105mm) Nasal tissue forceps 02-2100 Sharp head 02-2100.1 (L) B2100.2 (S) 02-2100M Sharp head 130mm</p>	 <p>(30°/105mm) Nasal tissue forceps 02-2101 Sharp head 02-2101.1 (L) 02-2101.2 (S)</p>	 <p>(105mm) Nasal tissue forceps (sharp head) 02-2102 45° 02-2103 90°</p>	
 <p>02-2080 (105mm) Open forceps of nasal ethmoid Flat head</p>	 <p>02-2081 (105mm) Open forceps of nasal ethmoid Up head</p>	 <p>(105mm) Open forceps of nasal ethmoid Sharp head 02-2082 (L) 02-2082.1 (S)</p>	 <p>02-2085 (150mm) Nasal-pharyngeal biopsy forceps Straight</p>	 <p>02-2086 (150mm) Nasal-pharyngeal biopsy forceps</p>	
 <p>02-2086.1 (150mm) 70° Nasal-pharyngeal biopsy forceps Upward</p>	 <p>02-2087 (180mm) Nasal-pharyngeal biopsy forceps Curved</p>	 <p>02-2095.1 (105mm) Nasal tissue scissors Straight</p>	 <p>(105mm) Nasal tissue scissors 02-2096.1 Left-curved 02-2097.1 Right-curved</p>	 <p>02-2098 (105mm) Nasal rongeur front-biting</p>	
 <p>02-2099 (105mm) Back biting rongeur 02-2099M 130mm 02-2099.1 left opening 02-2099.2 right opening 02-2099.1M 130mm left open 02-2099.2M (长130mm) right open</p>	 <p>02-2099.3 (105mm) Back biting rongeur Down curved</p>	 <p>02-2099.9 (105mm) Suture removing forceps</p>	 <p>02-2099.10 (105mm) Foreign body forceps</p>	 <p>(0°/105mm) Polyp forceps of nasal cavity 02-2104 Round head</p>	

NASAL OPERATING FORCEPS

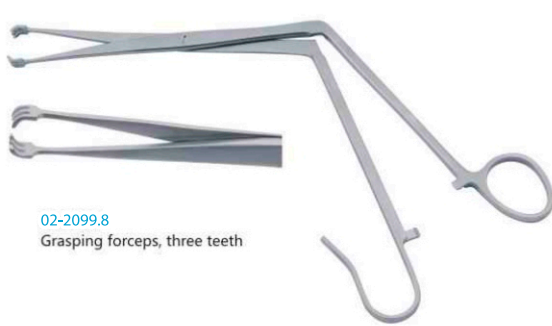

02-2099.8
Grasping forceps, three teeth

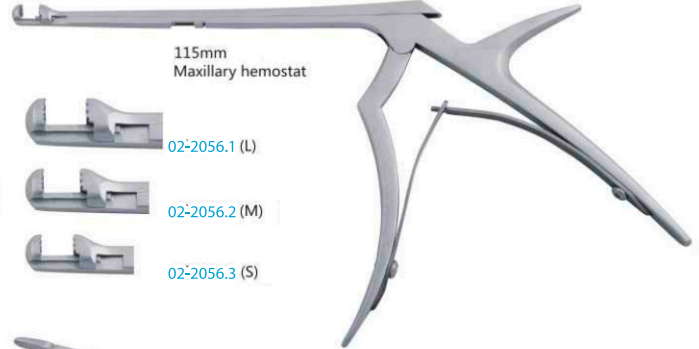

115mm
Maxillary hemostat

02-2056.1 (L)

02-2056.2 (M)

02-2056.3 (S)



02-2018.1 (200mm)
Nasal mucosa forceps, type 1
02-2018.2 (200mm)
Nasal mucosa forceps, type 2



Nasal polyp forceps, triticeous head
02-2025.1 2×6×180mm
02-2025.2 2.5×6×180mm
02-2025.3 3×6×180mm



Nasal polyp forceps, new type
02-2026.1 2×6mm
02-2026.2 2.5×6mm
02-2026.3 3×6mm

Nasal mucosa forceps, new type
02-2018.3 (L)
02-2018.4 (M)
02-2018.5 (S)



Nasal polyp forceps
02-2027.1 2×6
02-2027.2 2.5×6
02-2027.3 3×6



02-2050
Straight upward



02-2051
Straight downward



02-2052 45°
Upward



02-2053 45°
Downward



02-2054
Straight upward, mouth with tooth



02-2055
Straight downward, mouth with tooth



130mm
Maxillary hemostat

NASAL OPERATING FORCEPS

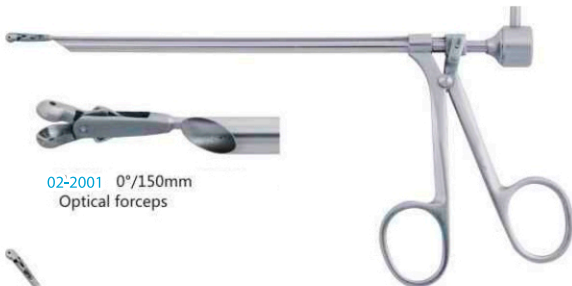

02-2001 0°/150mm
Optical forceps



02-2002 30°/120mm
Optical forceps, flexible



02-2003 70°/120mm
Optical forceps



(M1020)
Nasal bipolar forceps
Use with M1020 high frequency cord
02-2125 0°
02-2125.1 20° Upward 20°

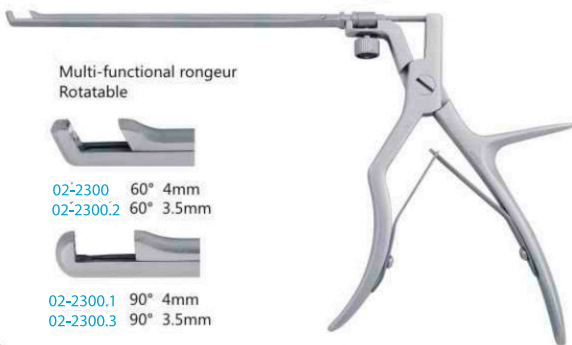

Multi-functional rongeur
Rotatable

02-2300 60° 4mm
02-2300.2 60° 3.5mm

02-2300.1 90° 4mm
02-2300.3 90° 3.5mm



Detachable rongeur Rotatable

02-2301 60° 4mm
02-2301.2 60° 3.5mm
02-2301.4 60° 3mm

02-2301.1 90° 4mm
02-2301.3 90° 3.5mm
02-2301.5 90° 3mm



Side cutting forceps
02-2522 left biting
02-2523 right biting



(360°)
Back biting rongeur, Rotatable
02-2513
02-2513.1
02-2513.2



(100mm)
Nasal rongeur, sharp head
02-2530 0° 02-2531 30°
02-2532 45° 02-2533 90°

(2mm)
Nasal tissue cutting forceps
02-2534 0° 02-2535 30° 02-2536 45°

NASAL OPERATING FORCEPS



0°
Detachable suction polyp forceps
02-2162.1 $\Phi 5 \times 140\text{mm}$
02-2162.2 $\Phi 4 \times 140\text{mm}$
02-2162.3 $\Phi 3 \times 140\text{mm}$



02-2030 180mm
Nasal stamping forceps



02-1001 30mm
Adult nasal speculum
02-1002 20mm
Pediatric nasal speculum



02-1001.2 30mm
Adult nasal speculum



02-1003 50mm
Operation nasal speculum

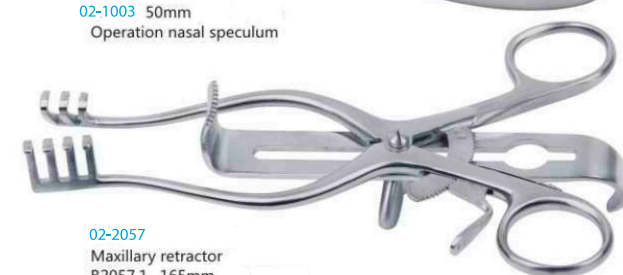

02-2057
Maxillary retractor
B2057.1 165mm
Maxillary retractor



02-2071
Nasal bone resetting forceps

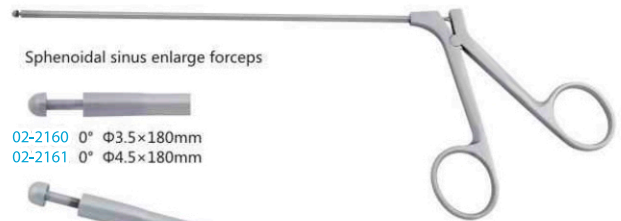

Sphenoidal sinus enlarge forceps

02-2160 0° $\Phi 3.5 \times 180\text{mm}$
02-2161 0° $\Phi 4.5 \times 180\text{mm}$



02-2160.1 30° $\Phi 3.5 \times 180\text{mm}$
02-2161.1 30° $\Phi 4.5 \times 180\text{mm}$

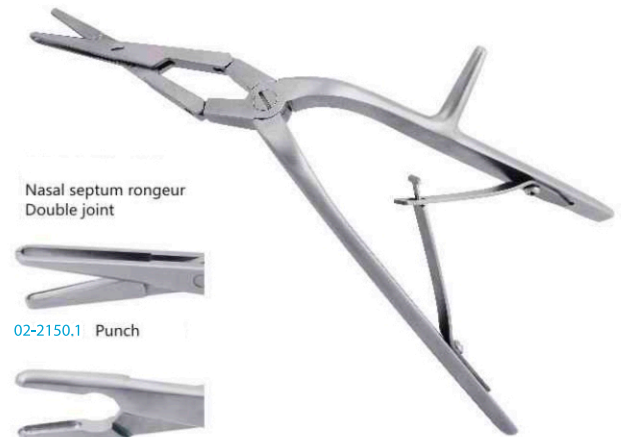

Nasal septum rongeur
Double joint

02-2150.1 Punch



02-2150.2 Occlude



02-2032
Nasal mouth gag



02-2024
Nasal polyp snare

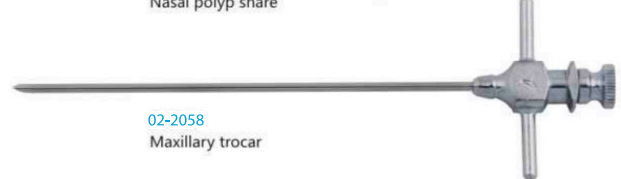

02-2058
Maxillary trocar



02-2058.1
Connection tube

NASAL INSTRUMENTS



NASAL INSTRUMENTS



Nasal septum fish tail chisel, straight
02-2059.1 (L)
02-2059.2 (M)
02-2059.3 (S)



Nasal bone chisel



Double protection
02-2072.1 6mm
02-2072.2 8mm



Left protection
02-2073.1 6mm
02-2073.2 8mm



Right protection
02-2074.1 6mm
02-2074.2 8mm



Nasal septum swivel knife, straight
02-2068.1 3mm
02-2068.2 4mm
02-2068.3 5mm

Nasal septum swivel knife, tip, straight
02-2068.4 3mm
02-2068.5 4mm
02-2068.6 5mm



Barnhill adenoid curette, without hook
02-2091.1 (L)
02-2091.2 (M)
02-2091.3 (S)



02-2031.1 (190mm)
Nasal cartilage knife, double heads



02-2031.2
Nasal cartilage knife, double heads



Sickle knife



02-2118 Sharp head curved



02-2119 Blunt head curved



02-2220
Nasal probe



Nasal septum fish tail chisel, bayonet shaped
02-2060.1 (L)
02-2060.2 (M)
02-2060.3 (S)



02-2075
Nasal bone chisel
Flat, curved



02-2076
Nasal bone chisel
Bayonet shaped, half round



Nasal septum swivel knife, bayonet
02-2069.1 3mm 02-2069.2 4mm 02-2069.3 5mm



Barnhill adenoid curette, with hook
02-2092.1 (L)
02-2092.2 (M)
02-2092.3 (S)



Nasal bone restorer
02-2070



Nasal bone restorer
02-2070.1



02-2127 (6×42mm)
Nasal rasp, double sides rasp



02-2163 (180mm)
Maxillary retractor
Double heads



02-2120 (Φ4.2×100mm)
Trocar



02-2121
Endoscope holder



02-2077
Nosepiece scissors
Upperbound

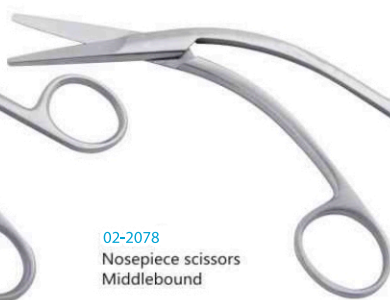

02-2078
Nosepiece scissors
Middlebound



02-2079
Nosepiece scissors
Lowerbound

NASAL SUCTION TUBE

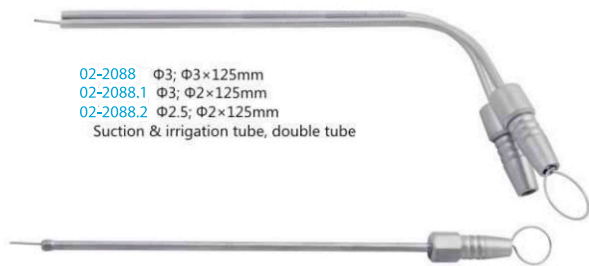

02-2088 $\Phi 3$; $\Phi 3 \times 125\text{mm}$
 02-2088.1 $\Phi 3$; $\Phi 2 \times 125\text{mm}$
 02-2088.2 $\Phi 2.5$; $\Phi 2 \times 125\text{mm}$
 Suction & irrigation tube, double tube

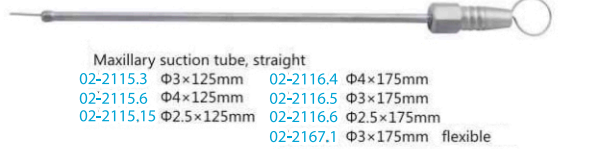

Maxillary suction tube, straight
 02-2115.3 $\Phi 3 \times 125\text{mm}$ 02-2116.4 $\Phi 4 \times 175\text{mm}$
 02-2115.6 $\Phi 4 \times 125\text{mm}$ 02-2116.5 $\Phi 3 \times 175\text{mm}$
 02-2115.15 $\Phi 2.5 \times 125\text{mm}$ 02-2116.6 $\Phi 2.5 \times 175\text{mm}$
 02-2167.1 $\Phi 3 \times 175\text{mm}$ flexible

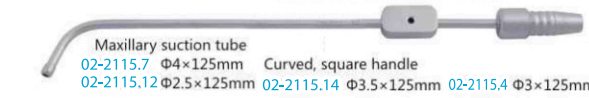

Maxillary suction tube
 02-2115.7 $\Phi 4 \times 125\text{mm}$ Curved, square handle
 02-2115.12 $\Phi 2.5 \times 125\text{mm}$ 02-2115.14 $\Phi 3.5 \times 125\text{mm}$ 02-2115.4 $\Phi 3 \times 125\text{mm}$



Maxillary suction tube
 02-2115.8 $\Phi 3.5 \times 140\text{mm}$ hook sharpended
 02-2115.9 $\Phi 3 \times 125\text{mm}$ hook sharpended
 02-2115.10 $\Phi 2.5 \times 125\text{mm}$ hook sharpended

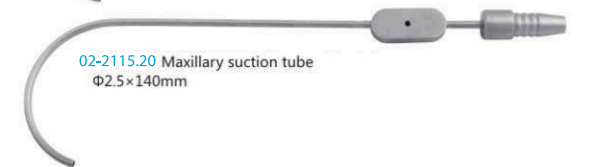

02-2115.20 Maxillary suction tube
 $\Phi 2.5 \times 140\text{mm}$

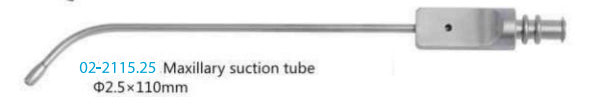

02-2115.25 Maxillary suction tube
 $\Phi 2.5 \times 110\text{mm}$



150mm
 Suction tube, curved, square handle
 02-2116.10 $\Phi 4\text{mm}$ 02-2116.13 $\Phi 2.5\text{mm}$ 02-2116.16 $\Phi 4.0\text{mm}$
 02-2116.11 $\Phi 3\text{mm}$ 02-2116.14 $\Phi 3.0\text{mm}$
 02-2116.12 $\Phi 2.5\text{mm}$ 02-2116.15 $\Phi 3.5\text{mm}$

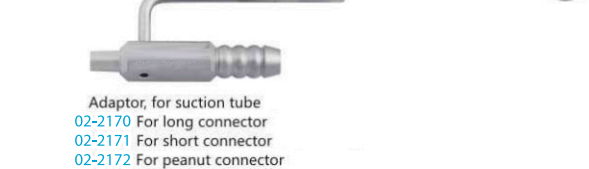

Adaptor, for suction tube
 02-2170 For long connector
 02-2171 For short connector
 02-2172 For peanut connector



Suction tube for treatment table, long connector
 02-2170.1 $\Phi 1.5\text{mm}$ 02-2170.2 $\Phi 2\text{mm}$
 02-2170.3 $\Phi 2.5\text{mm}$ 02-2170.4 $\Phi 3\text{mm}$
 02-2170.5 $\Phi 3.5\text{mm}$

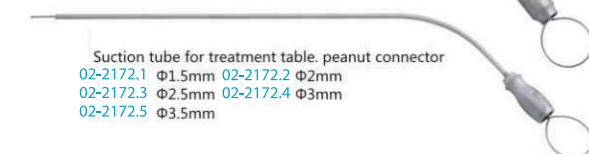

Suction tube for treatment table, peanut connector
 02-2172.1 $\Phi 1.5\text{mm}$ 02-2172.2 $\Phi 2\text{mm}$
 02-2172.3 $\Phi 2.5\text{mm}$ 02-2172.4 $\Phi 3\text{mm}$
 02-2172.5 $\Phi 3.5\text{mm}$

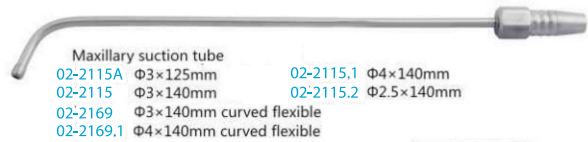

Maxillary suction tube
 02-2115A $\Phi 3 \times 125\text{mm}$ 02-2115.1 $\Phi 4 \times 140\text{mm}$
 02-2115 $\Phi 3 \times 140\text{mm}$ 02-2115.2 $\Phi 2.5 \times 140\text{mm}$
 02-2169 $\Phi 3 \times 140\text{mm}$ curved flexible
 02-2169.1 $\Phi 4 \times 140\text{mm}$ curved flexible

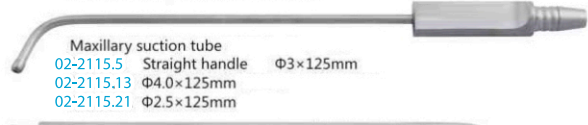

Maxillary suction tube
 02-2115.5 Straight handle $\Phi 3 \times 125\text{mm}$
 02-2115.13 $\Phi 4.0 \times 125\text{mm}$
 02-2115.21 $\Phi 2.5 \times 125\text{mm}$

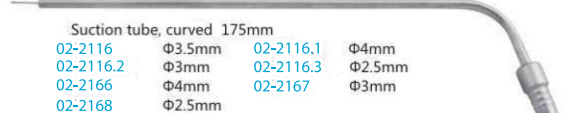

Suction tube, curved 175mm
 02-2116 $\Phi 3.5\text{mm}$ 02-2116.1 $\Phi 4\text{mm}$
 02-2116.2 $\Phi 3\text{mm}$ 02-2116.3 $\Phi 2.5\text{mm}$
 02-2166 $\Phi 4\text{mm}$ 02-2167 $\Phi 3\text{mm}$
 02-2168 $\Phi 2.5\text{mm}$



Maxillary suction tube square handle
 02-2115.16 $\Phi 2.5 \times 110\text{mm}$ Straight
 02-2115.17 $\Phi 3.0 \times 110\text{mm}$ Straight
 02-2115.18 $\Phi 4.0 \times 110\text{mm}$ Straight

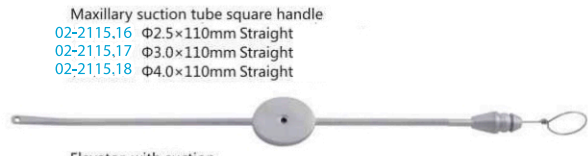

Elevator, with suction
 02-2117.1 $\Phi 3\text{mm}$
 02-2117.2 $\Phi 4\text{mm}$

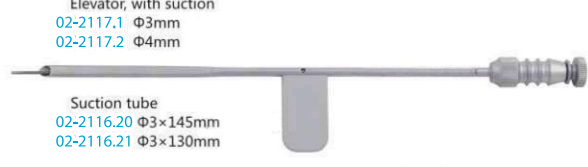

Suction tube
 02-2116.20 $\Phi 3 \times 145\text{mm}$
 02-2116.21 $\Phi 3 \times 130\text{mm}$

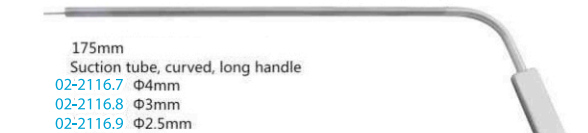

175mm
 Suction tube, curved, long handle
 02-2116.7 $\Phi 4\text{mm}$
 02-2116.8 $\Phi 3\text{mm}$
 02-2116.9 $\Phi 2.5\text{mm}$

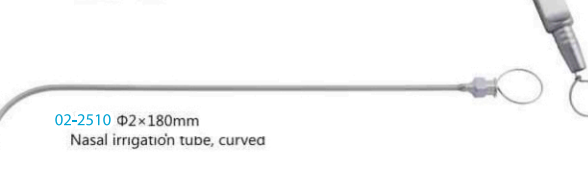

02-2510 $\Phi 2 \times 180\text{mm}$
 Nasal irrigation tube, curved

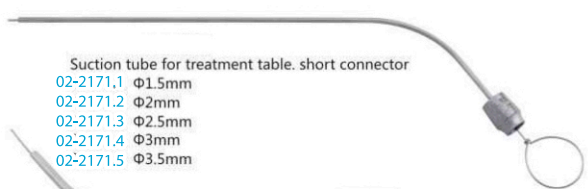

Suction tube for treatment table, short connector
 02-2171.1 $\Phi 1.5\text{mm}$
 02-2171.2 $\Phi 2\text{mm}$
 02-2171.3 $\Phi 2.5\text{mm}$
 02-2171.4 $\Phi 3\text{mm}$
 02-2171.5 $\Phi 3.5\text{mm}$

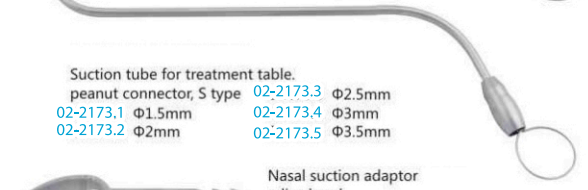

Suction tube for treatment table, peanut connector, S type
 02-2173.1 $\Phi 1.5\text{mm}$ 02-2173.3 $\Phi 2.5\text{mm}$
 02-2173.2 $\Phi 2\text{mm}$ 02-2173.4 $\Phi 3\text{mm}$
 02-2173.5 $\Phi 3.5\text{mm}$

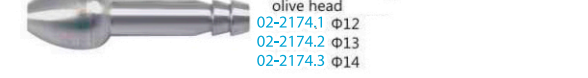

Nasal suction adaptor olive head
 02-2174.1 $\Phi 12$
 02-2174.2 $\Phi 13$
 02-2174.3 $\Phi 14$

NASAL SUCTION TUBE



Φ5×195mm
 Nasal mastoid suction tube, straight
 02-2511.1 Φ5mm B2511.2 Φ4mm 02-2511.3 Φ3mm
 02-2511.4 Φ4.5×195mm
 02-2511.5 Φ3.5×195mm
 02-2511.7 Φ4×195mm
 02-2511.15 Φ2.5×195mm

Φ5×195mm
 Nasal mastoid suction tube, curved
 02-2512.1 Φ5mm 90°
 02-2512.2 Φ4mm 02-2512.4 Φ4×195mm 02-2512.7 Φ3.5×195mm
 02-2512.3 Φ3mm 02-2512.6 90° Φ5×195mm 02-2512.8 Φ3×195mm

PEDIATRIC NASAL INSTRUMENTS



02-2201

Pediatric optical forceps(/Φ3mm)
 02-2201 0°
 02-2202 30°
 02-2203 70°

02-2203

Φ3×110mm
 Nasal tissue scissors

02-2205 Straight

02-2207 Right-curved
 02-2206 Left-curved

Tissue forceps of nasal cavity
 02-2039.2 0° 02-2041.2 45°
 02-2040.2 30° 02-2042.2 90°

02-2094.3 0°
 Cutting forceps of nasal
 ethmoid(S)

02-2094.4 30°
 Cutting forceps of nasal
 ethmoid(S)

02-2209
 0°/95mm
 Tissue forceps of nasal cavity,
 Sharp head 0°

02-2210
 30°/95mm
 Tissue forceps of nasal cavity,
 Sharp head 30°

02-2211
 45°/95mm
 Tissue forceps of nasal cavity,
 Sharp head 45°

02-2212
 90°/95mm
 Tissue forceps of nasal cavity,
 Sharp head 90°

02-2208
 95mm
 Sinus rongeur, back-biting

02-2213
 0°
 Tissue forceps of nasal cavity,
 round head

02-2214
 30°
 Tissue forceps of nasal cavity,
 round head

NASAL POWER DRILL



BD-9 NASAL POWER DRILL



02-3103.2
Oblique with tooth, irrigation



02-3104.2
Oblique without tooth, irrigation



02-3105.2
With tooth inside and outside, irrigation



02-3106.1 ϕ 4mm
Ball shaped



Φ 4.5mm
Oblique with tooth on obverse side
02-3107.1 20°
02-3109.1 40°
02-3111.1 60°



Φ 4.5mm
Oblique with tooth on inverse side
02-3108.1 20°
02-3110.1 40°
02-3112.1 60°

NASAL ELECTRIC COAGULATOR WITH SUCTION



13:1002
Elevator suction tube, use with 13:1002
02-2501 $\Phi 4 \times 100\text{mm}$
02-2501.1 $\Phi 3.5 \times 100\text{mm}$



13:1002
Nasal electric coagulator with suction, flat, use with 13:1002
02-2122 $\Phi 3\text{mm}$
02-2122.4 $\Phi 4\text{mm}$



02-2122.8
Nasal electric coagulator elevator with suction
Slightly curved $\Phi 3.4 \times 130\text{mm}$



(0°/170mm/02-1006)
Nasal electric coagulator with suction, flat, bipolar, use with 02-1006
02-2124 $\Phi 4\text{mm}$
02-2124.3 $\Phi 3\text{mm}$
02-2124.5 $\Phi 5\text{mm}$



(170mm/02-1006)
Nasal electric coagulator with suction, flat, bipolar, use with B1006
02-2124.1 $\Phi 4\text{mm}$ 15°
02-2124.4 $\Phi 3\text{mm}$ 15°
02-2124.7 $\Phi 5\text{mm}$ 15°



13:1002
Nasal electric coagulator with suction, flat, use with 13:1002
Flat

02-2122.2 60° $\Phi 3\text{mm}$
02-2122.3 90° $\Phi 3\text{mm}$
02-2122.6 60° $\Phi 4\text{mm}$
02-2122.7 90° $\Phi 4\text{mm}$



13:1002
Nasal electric coagulator with suction, flat, use with 13:1002
02-2122.1 50° $\Phi 3\text{mm}$
02-2122.5 50° $\Phi 4\text{mm}$
02-2123.1 45° $\Phi 3\text{mm}$
02-2123.2 45° $\Phi 4\text{mm}$

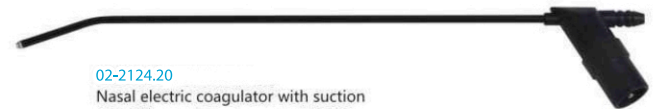

02-2124.20
Nasal electric coagulator with suction
 $\Phi 3 \times 240\text{mm}$ 0°, 13:1020
flat, 0°, bipolar, use with 13:1020



(170mm/02-1006)
Nasal electric coagulator with suction, flat, bipolar, curved, use with 02-1006
02-2124.2 $\Phi 4\text{mm}$ 45°
02-2124.6 $\Phi 5\text{mm}$ 45°

LARYNGOSCOPE

- Connecting to TIANSONG light guide cable
OLYMPUS
Connecting to OLYMPUS light guide cable
STORZ
Connecting to STORZ light guide cable
- Connecting to WOLF light guide cable
ACMI STRYKER
- Connecting to ACMI STRYKER light guide cable

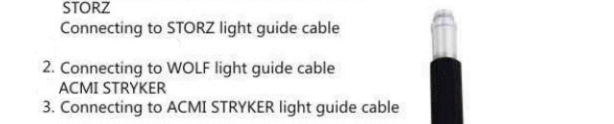

04-0101 90° $\Phi 8 \times 174\text{mm}$

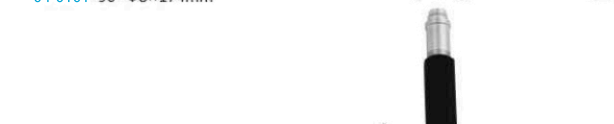

Tele-laryngoscope
04-0102 90° $\Phi 8 \times 174\text{mm}$
04-0103 70° $\Phi 8 \times 178\text{mm}$



04-0105 70° $\Phi 5 \times 175\text{mm}$
04-0105.1 70° $\Phi 5 \times 175\text{mm}$
134°C 2bar Autoclavable



04-0104.1 70° $\Phi 8 \times 170\text{mm}$
04-0112 70° $\Phi 8 \times 170\text{mm}$
134°C 2bar Autoclavable



Side viewing Laryngoscope
04-0106.1 12° $\Phi 4 \times 185\text{mm}$
04-0107.1 0° $\Phi 4 \times 183\text{mm}$

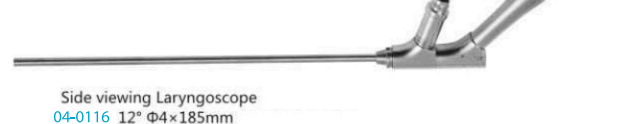

Side viewing Laryngoscope
04-0116 12° $\Phi 4 \times 185\text{mm}$
04-0117 0° $\Phi 4 \times 183\text{mm}$

SELF-RETAINING LARYNGOSCOPY SET



04-6001
Laryngoscope holder



Light guide cable
Screw adaptor
04-5010 $\Phi 2.5 \times 1700\text{mm}$
10-5010 $\Phi 1.8 \times 1700\text{mm}$
Click adaptor
21-5013 $\Phi 1.8 \times 1700\text{mm}$
21-5014 $\Phi 2.5 \times 1700\text{mm}$



Laryngoscope holder
04-6002 04-1003, 04-1004
04-6003

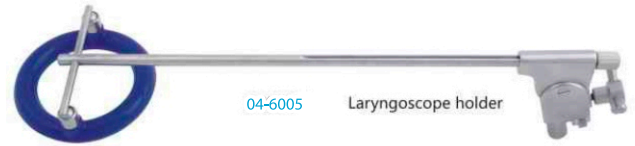

04-6005 Laryngoscope holder

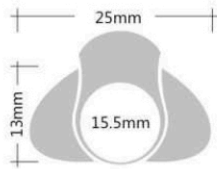

Oval (L)

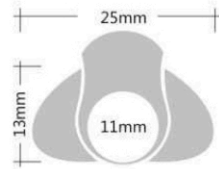

Oval (S)

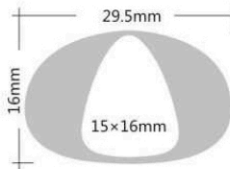

Triangle (L)

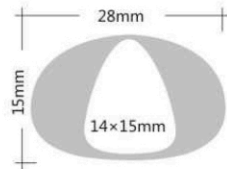

Triangle (S)



Expanding laryngoscope tube
04-1016 04-5020.1
For side-viewing laryngoscope
04-1017 12°



04-2083
Laryngoscope tube, for 04-2083
04-1001 (L) 170mm
04-1002 (S) 170mm



Laryngoscope tube
04-1003 (L) 175mm
04-1004 (S) 175mm



Laryngoscope tube
04-1011 (L) 175mm
04-1012 (S) 175mm



12° Laryngoscope tube for 12° endoscope
04-1013,1 (L) 175mm
04-1014,1 (S) 175mm
0° Laryngoscope tube for 0° endoscope
04-1013 (L) 175mm
04-1014 (S) 175mm



04-5020.1
Laryngoscope tube
04-2101 (L) 150mm
04-2102 (S) 130mm



Laryngoscope tube
04-2103 (L) 11x150mm
04-2104 (S) 11x130mm

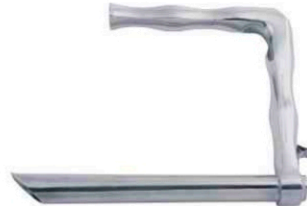

Direct laryngoscope tube
04-2076.1 (L) 16x175mm
04-2076.2 (M) 14x175mm
04-2076.3 (S) 12x175mm



Lateral laryngoscope tube
04-2077.1 (L) 16x175mm
04-2077.2 (M) 14x150mm
04-2077.3 (S) 12x100mm

LARYNGEAL OPERATING FORCEPS



Micro-laryngeal forceps

- 04-2001 Micro-laryngeal forceps, straight
- 04-2002 30° Micro-laryngeal forceps
- 04-2003 left-curved 30°
- 04-2004 right-curved 30°
- 04-2005 45° Micro-laryngeal forceps, with tooth 45°
- 04-2006 Micro-laryngeal forceps, cutting
- 04-2007 Micro-laryngeal forceps, biopsy
- 04-2008 Micro-laryngeal forceps, barb tooth
- 04-2009 Micro-laryngeal forceps, grasping
- 04-2010 0° Micro-laryngeal forceps triangular head
- 04-2011 45° Micro-laryngeal forceps triangular head
- 04-2012 Micro-laryngeal scissors, straight
- 04-2013 left-curved
- 04-2014 right-curved
- 04-2015 15° Micro-laryngeal scissors
- 04-2016 45° Micro-laryngeal scissors
- 04-2017 45° Micro-polyp forceps, open to left
- 04-2018 45° Micro-polyp forceps, open to right
- 04-2019 Left fish-mouth
- 04-2020 Right fish-mouth
- Micro-laryngeal forceps
 - 04-3015 45° 2*230mm
 - 04-3016 45° 2*230mm
 - 04-3017 45° 2*230mm
- Micro-laryngeal scissors
 - 04-3021 2*230mm
 - 04-3022 2*230mm
 - 04-3023 2*230mm

230mm Direct laryngeal forceps

- 04-2045 Crocodile head
- 04-2048 45° Upward
- 04-2046 Left kidney shaped
- 04-2047 Right kidney shaped
- 04-2049 Triangular head
- 04-2050 45° Upward/Triangular head
- 04-2051 Cup head
 - Cup head 30°
 - 04-2085.1 Φ5mm
 - 04-2085.2 Φ4mm
 - 04-2085.3 Φ3mm

Laryngeal foreign body forceps

- 04-3001 270mm open to up
- 04-3002 270mm open to down
- 04-3003 270mm open to left
- 04-3004 270mm open to right
- 04-3005 45°, 250mm Head upward 45°, Cup head
- 04-3005.1 15°, 45° Stick upward 15°, Head upward 45°
- 04-3006 45° 250mm Head upward 45°
- 04-3006.1 15°, 45°, 250mm Stick up-curved 15°, Head upward 45°
- 04-3006.3 45°, 250mm Head upward 45°, Triangle

LARYNGEAL OPERATING FORCEPS



04-2070 260mm
Indirect laryngeal forceps
One handle with three jaws, rotating head



04-2055
Laryngeal pustule cutting forceps
With suction & irrigation



260mm Polyp forceps of vocal cord	45° 260mm Special polyp forceps of vocal cord	260mm Special laryngeal forceps
04-2021 Rotating head	04-2026 Open to front	04-2030 Rotating head
04-2022 Open to front	04-2027 Open to back	04-2031 Upward
04-2023 Open to back	04-2028 Open to left	04-2032 Downward
04-2024 Open to left	04-2029 Open to right	04-2033 Leftward
04-2025 Open to right		04-2034 Rightward

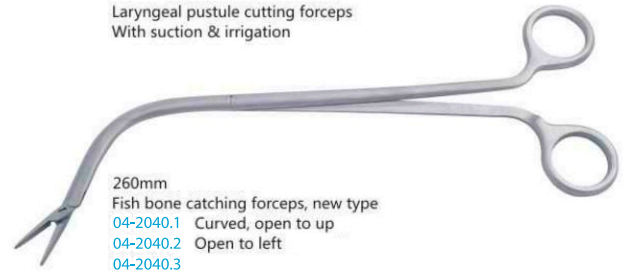

260mm
Fish bone catching forceps, new type
04-2040.1 Curved, open to up
04-2040.2 Open to left
04-2040.3



260mm Fish bone catching forceps	04-2041 Laryngeal scissors	04-2041 260mm Laryngeal pustule cutting forceps Open to left & right
04-2035 Open to front		
04-2036 Open to left		
04-2037 Open to right		
04-2038 Open to back		
04-2039 Rotating head		
04-2040 Open to left & right		



Indirect laryngeal forceps	Indirect laryngeal forceps
04-2071 Open to left	04-2071.1 Open to left
04-2072 Open to right	04-2072.1 Open to right
04-2073 Open to up	04-2073.1 Open to up
04-2074 Open to down	04-2074.1 Open to down



04-1009.1 112mm
Laryngoscope blade



04-1010.1 132mm
Laryngoscope blade



04-1009.2 100mm
Laryngoscope blade



04-1010.2 130mm
Laryngoscope blade



04-1008.1 92mm
Laryngoscope blade



04-1008.2 92mm
Laryngoscope blade



04-1007.1 77mm
Laryngoscope blade



04-1007.2 80mm
Laryngoscope blade

MYJ-2
Anesthetic laryngoscope, fiber optic

21-5007.1
Minitype light source

MYJ-3
Anesthetic laryngoscope, with lamp

21-5007.2
Minitype light source

LARYNGEAL INSTRUMENT



04-2057
Tonsil gland scissors

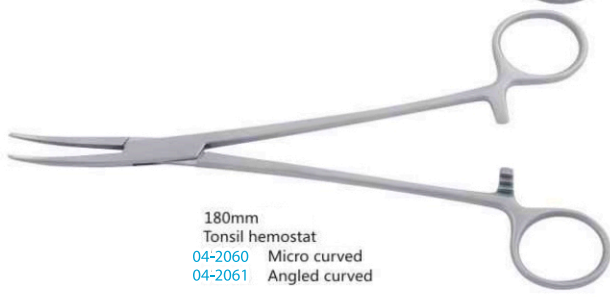

180mm
Tonsil hemostat
04-2060 Micro curved
04-2061 Angled curved

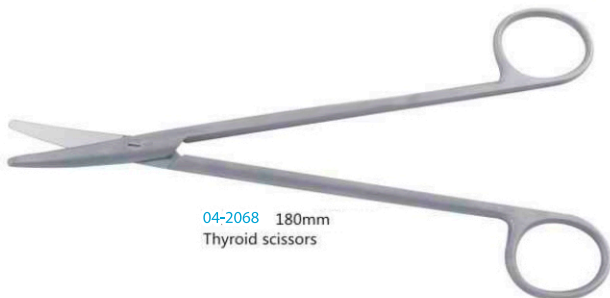

04-2068 180mm
Thyroid scissors



04-2064
Tonsil elevator



Tonsil retractor
04-2065 2 claws, blunt head
04-2065.1 2 claws, sharp head



220mm
Tonsil holding forceps
04-2058 Angled with 3 claws
04-2059 Angled with teeth

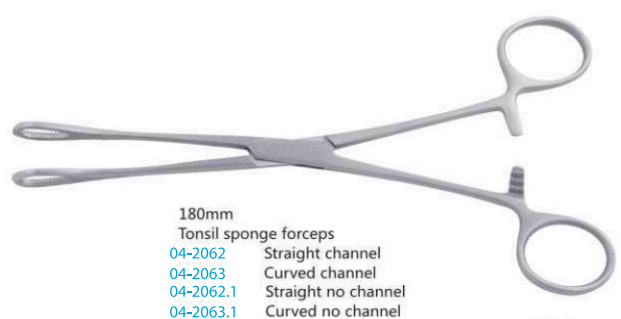

180mm
Tonsil sponge forceps
04-2062 Straight channel
04-2063 Curved channel
04-2062.1 Straight no channel
04-2063.1 Curved no channel

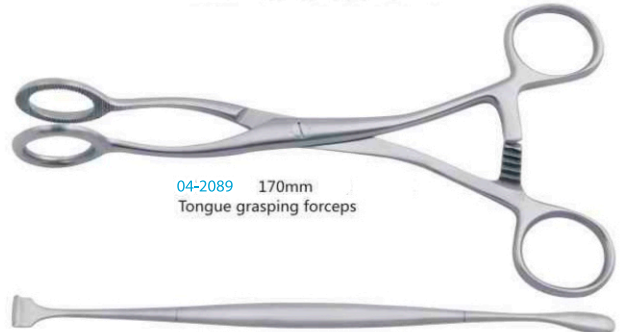

04-2089 170mm
Tongue grasping forceps

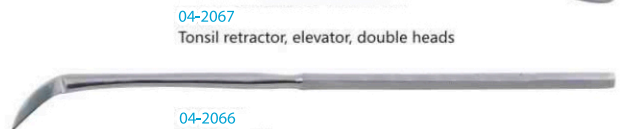

04-2067
Tonsil retractor, elevator, double heads



04-2066
Tonsil knife



04-2078 (250mm)
Laryngotome



04-2079 (250mm)
Laryngeal needle



04-2080 (250mm)
Laryngeal hook

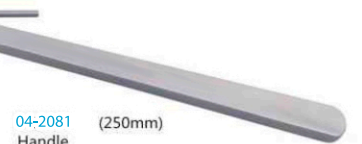

04-2081 (250mm)
Handle



04-2097 (230mm) 02-1006
Laryngeal electric coagulator with suction bipolar,
flat $\Phi 5 \times 240\text{mm} / 45^\circ$

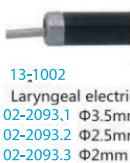

13-1002
Laryngeal electric coagulator with suction
02-2093.1 $\Phi 3.5\text{mm}$
02-2093.2 $\Phi 2.5\text{mm}$
02-2093.3 $\Phi 2\text{mm}$



13-1002
Laryngeal electric hook
02-2094.1 $\Phi 3.5\text{mm}$
02-2094.2 $\Phi 2.5\text{mm}$

LARYNGEAL INSTRUMENTS

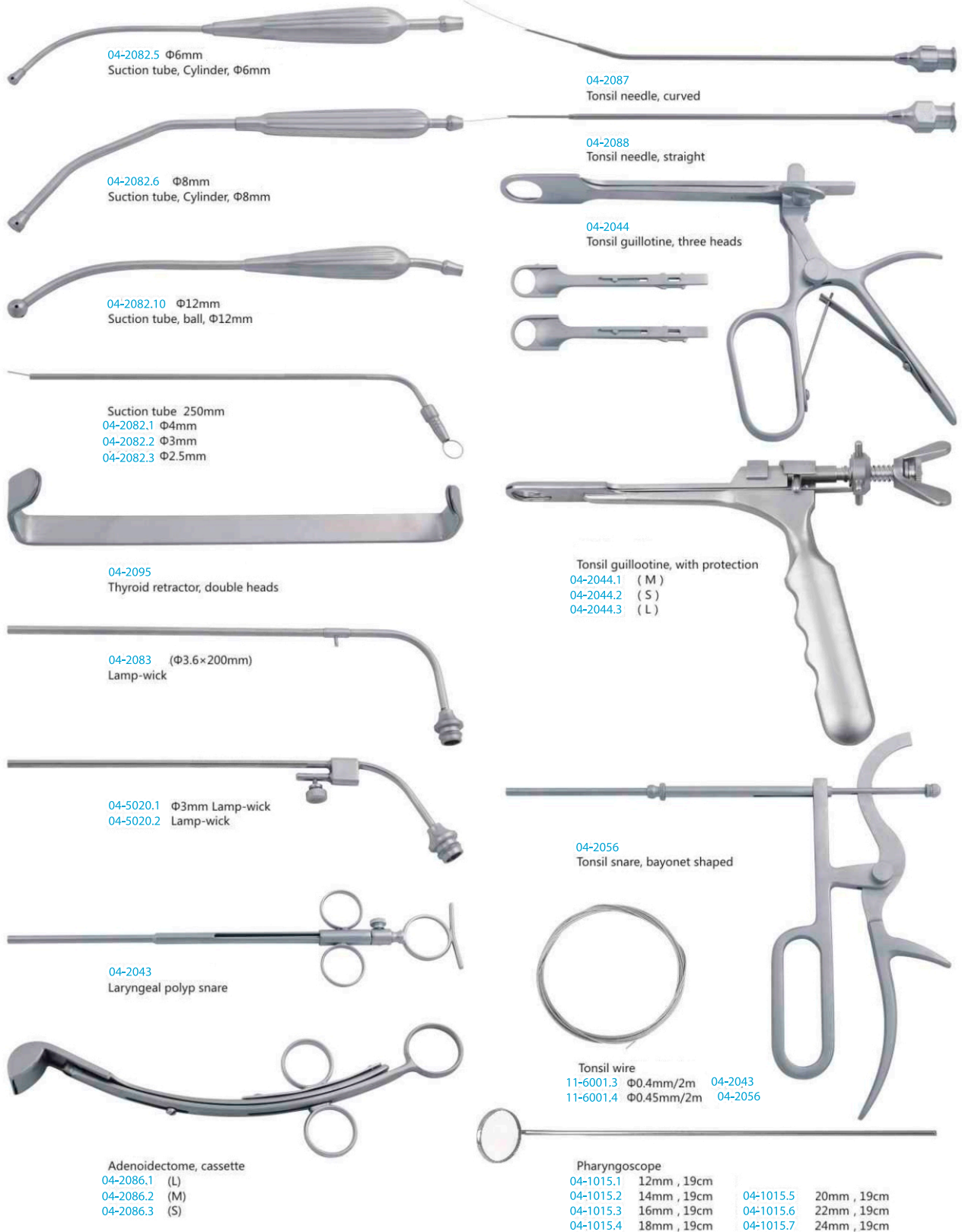

LARYNGEAL INSTRUMENT

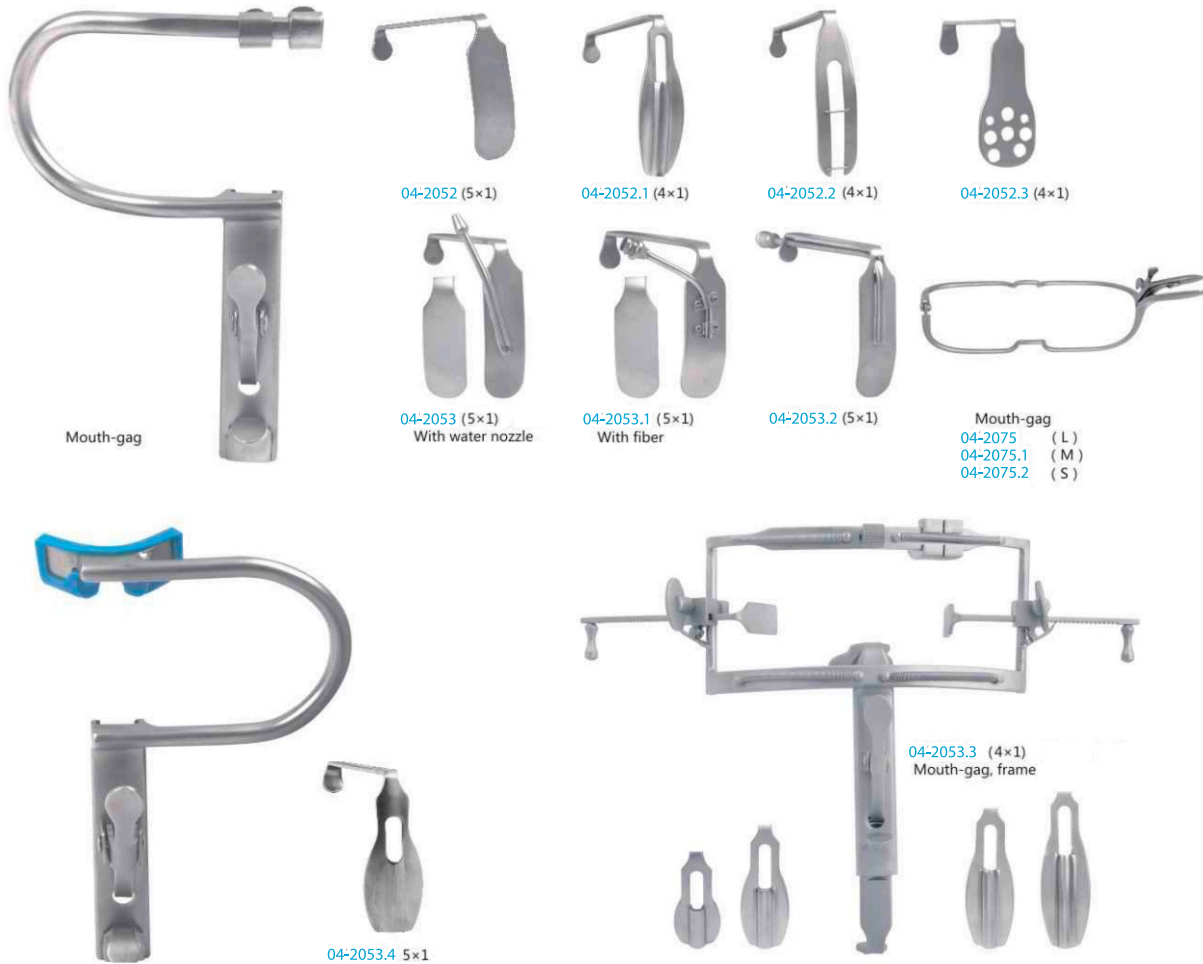

BRONCHOSCOPY INSTRUMENT

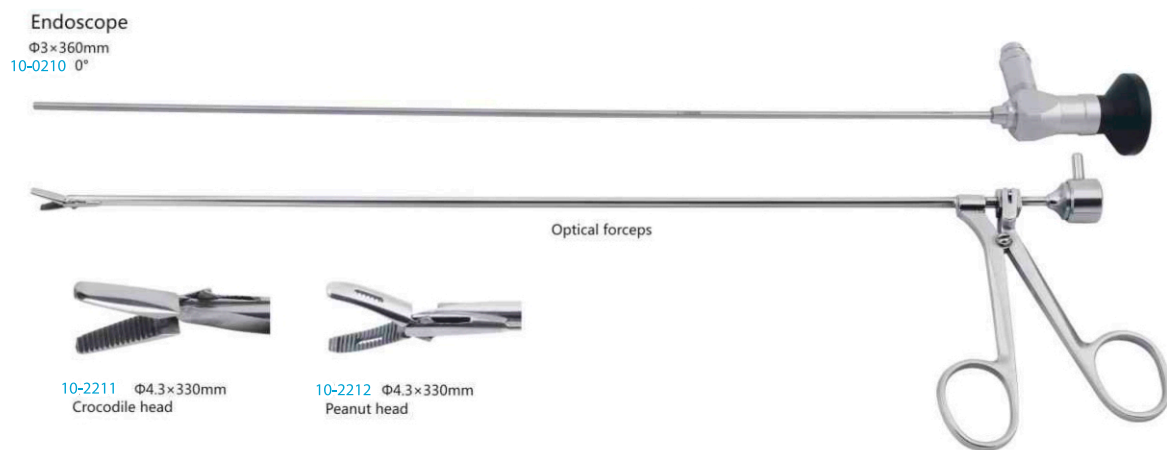

BRONCHOSCOPY INSTRUMENTS

Pediatric bronchoscope tube

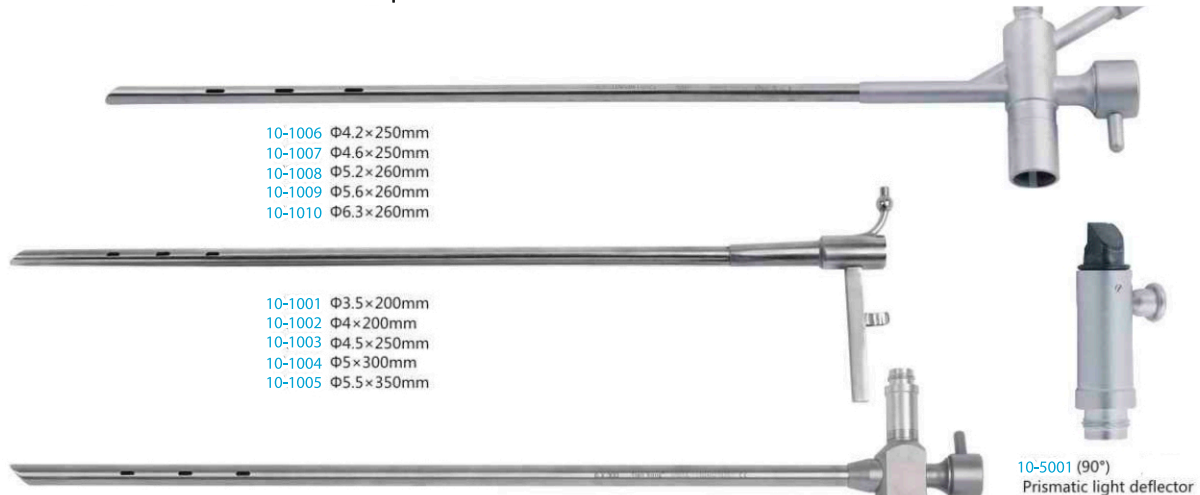

Fibers inside for illumination
 10-1011 $\Phi 4 \times 260\text{mm}$
 10-1012 $\Phi 4.5 \times 280\text{mm}$
 10-1013 $\Phi 5 \times 280\text{mm}$
 10-1014 $\Phi 5.5 \times 280\text{mm}$
 10-1015 $\Phi 6 \times 300\text{mm}$

Adult bronchoscope tube
 10-1016 $\Phi 6.5 \times 350\text{mm}$
 10-1017 $\Phi 7 \times 400\text{mm}$



BRONCHOSCOPY INSTRUMENT



10-2004 $\Phi 2.5 \times 360\text{mm}$
With two reverse claws



10-2005 $\Phi 2.5 \times 360\text{mm}$
With three claws



10-2009 $\Phi 2 \times 360\text{mm}$
Pen-sheath-carrying, With three claws



10-2012 $\Phi 2.5 \times 360\text{mm}$
With two claws



10-2013 $\Phi 2.5 \times 360\text{mm}$
Ring sharpened



10-2014 $\Phi 2.5 \times 360\text{mm}$
Front claw



10-2015 $\Phi 2.5 \times 360\text{mm}$
Peanut head

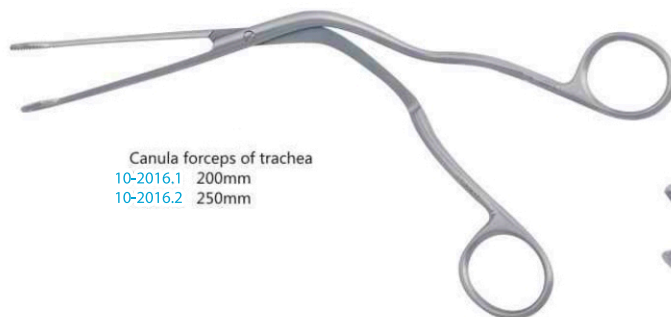

Canula forceps of trachea
10-2016.1 200mm
10-2016.2 250mm



10-2017
Tracheal dilating forceps



10-2017.1
Tracheal dilating forceps



Tracheal tube
10-1001.1 (4mm)
10-1001.2 (5mm)
10-1001.3 (6mm)
10-1001.4 (7mm)
10-1001.5 (8mm)
10-1001.6 (9mm)
10-1001.7 (10mm)
10-1001.8 (11mm)
10-1001.9 (12mm)
10-1001.10 (13mm)



Trigeminal tracheal tube
10-1002.1 (4mm)
10-1002.2 (5mm)
10-1002.3 (6mm)
10-1002.4 (7mm)
10-1002.5 (8mm)
10-1002.6 (9mm)
10-1002.7 (10mm)
10-1002.8 (11mm)
10-1002.9 (12mm)



Single tube of total throat
10-1003.1 (9mm)
10-1003.2 (10mm)
10-1003.3 (11mm)
10-1003.4 (12mm)
10-1003.5 (13mm)
10-1003.6 (14mm)



Double tube of total throat
10-1004.1 (9mm)
10-1004.2 (10mm)
10-1004.3 (11mm)
10-1004.4 (12mm)
10-1004.5 (13mm)
10-1004.6 (14mm)

BRONCHOSCOPY INSTRUMENTS



Guthrie retractor



10-2019 Two claws



10-2019.1 Four claws



Three claws
10-2019.3 Sharp head
10-2019.6 Blunt head



Demarres retractor

- 10-2019.10 8mm
- 10-2019.11 10mm
- 10-2019.12 12mm
- 10-2019.13 14mm
- 10-2019.14 16mm
- 10-2019.15 18mm



Suction tube

- 10-2020.1 (Φ2.5×350mm)
- 10-2020.2 (Φ3×350mm)
- 10-2020.3 (Φ4×350mm)

ESOPHAGOSCOPY INSTRUMENTS



- | | | |
|--------------------|-----------|--------------|
| Esophagoscope tube | 11-1001 | 8×10×200mm |
| | 11-1001.1 | 7.5×10×200mm |
| | 11-1001.2 | 8×11×180mm |
| | 11-1002.1 | 10×12×250mm |
| | 11-1002.2 | 10×12×300mm |
| | 11-1003.1 | 12×14×300mm |
| | 11-1003.2 | 12×14×350mm |
| | 11-1004 | 14×16×400mm |

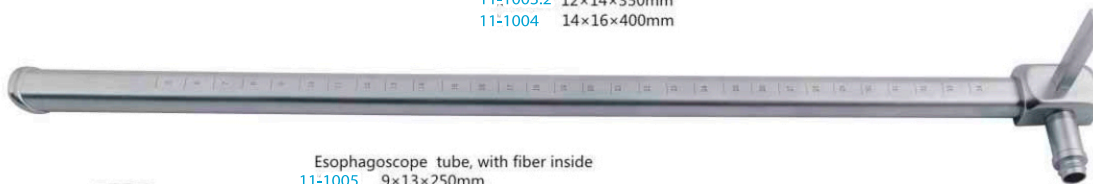

Esophagoscope tube, with fiber inside

- 11-1005 9×13×250mm
- 11-1005-D 7.5×10×250mm
- 11-1006 11×15×300mm
- 11-1007.1 10×16×360mm
- 11-1007.2 10×16×400mm
- 11-1008 13×17×380mm
- 11-1009.1 12×18×250mm
- 11-1009.2 12×18×400mm
- 11-1009.3 12×18×450mm



11-1000 Handle



11-2014
Spatula, straight



11-2015
Spatula, curved

ESOPHAGOSCOPY INSTRUMENT



Esophageal foreign body forceps



11-2002.1 $\Phi 4 \times 350\text{mm}$
 11-2002.2 $\Phi 4 \times 450\text{mm}$
 11-2003.1 $\Phi 4 \times 380\text{mm}$
 11-2003.2 $\Phi 4 \times 450\text{mm}$
 11-2003.3 $\Phi 4 \times 500\text{mm}$



11-2001.1 $\Phi 4 \times 350\text{mm}$
 11-2001.2 $\Phi 4 \times 450\text{mm}$
 11-2004.1 $\Phi 4 \times 380\text{mm}$
 11-2004.2 $\Phi 4 \times 450\text{mm}$
 11-2004.3 $\Phi 4 \times 500\text{mm}$



11-2005.1 $\Phi 4 \times 380\text{mm}$
 11-2005.2 $\Phi 4 \times 450\text{mm}$
 11-2005.3 $\Phi 4 \times 500\text{mm}$



11-2006.1 $\Phi 4 \times 380\text{mm}$
 11-2006.2 $\Phi 4 \times 450\text{mm}$
 11-2006.3 $\Phi 4 \times 500\text{mm}$



Esophageal foreign body forceps



11-2007
 ($\Phi 3.4 \times 450\text{mm}$)
 Left curved



11-2008
 ($\Phi 3.4 \times 450\text{mm}$)
 Right curved



11-2009
 ($\Phi 3.4 \times 450\text{mm}$)
 Rotatable



11-2012.2
 ($\Phi 4 \times 450\text{mm}$)
 Right curved



11-2012.1
 ($45^\circ / \Phi 4 \times 380\text{mm}$)
 Cup head



11-2010
 ($\Phi 3.4 \times 450\text{mm}$)
 Straight



11-2011
 ($\Phi 3.4 \times 450\text{mm}$)
 Esophageal scissor Straight



11-2013
 ($\Phi 4 \times 380\text{mm}$)
 Esophageal foreign body forceps Cutting



Suction tube

11-2016.1 $\Phi 4 \times 450\text{mm}$
 11-2016.2 $\Phi 3 \times 450\text{mm}$
 11-2016.3 $\Phi 2.5 \times 450\text{mm}$

CAMERA SYSTEM



01-2500.06 Full HD Camera system (1920x1080)
USB flash disk support for storage Full HD video and images



01-2500.04 Single Chip Camera System with USB
System for video and images.

COUPLER

Coupler, Straight



	Focal length
01-2513.1	F18
01-2512.3	F22
01-2513.3	F25
01-2512.1	F27
01-2517	F28
01-2512.5	F32
01-2512.6	F35

COLD LIGHT SOURCE



21-5040.1H LED



21-5007.6
Portable cold light source (with charger)



LIGHT GUIDE CABLE DIAGRAM

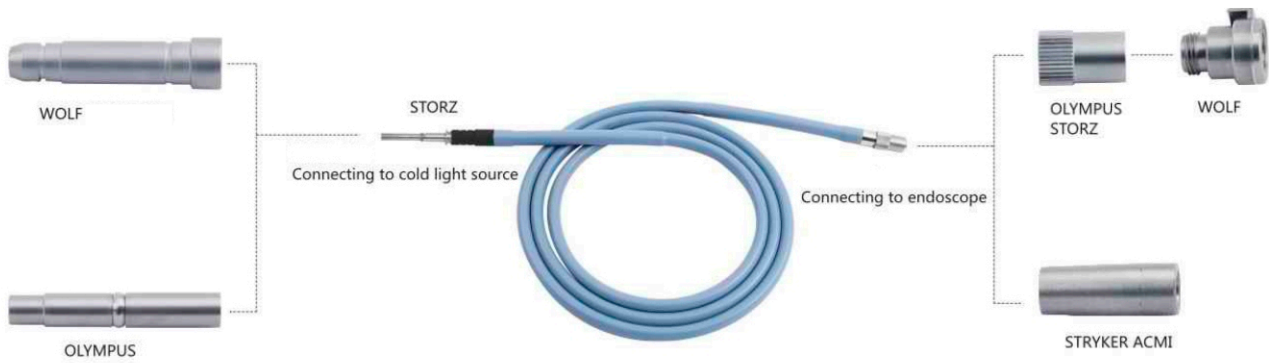

21-5010	Φ4.5×2000mm
21-5010.1	Φ4.5×1800mm
21-5010.2	Φ4.5×2000mm Autoclave
21-5010.3	Φ4.5×2000mm plasma
21-5012	Φ4.5×1800mm
21-5013	Φ1.8×1700mm
21-5014	Φ2.5×1700mm
21-5016.1	Φ1.8-Φ2.5 double head
21-5017	Φ2.5 double head
21-5018.2	Φ4.5×2300mm plasma
21-5018	Φ4.5×2300mm
21-5018.1	Φ4.5×2300mm Autoclave
21-5020	Φ4.5×2500mm
21-5020.2	Φ4.5×2500mm Autoclave
21-5020.3	Φ4.5×2500mm plasma

21-5021	Φ4.5×3000mm
21-5021.1	Φ4.5×3500mm
21-5021.2	Φ4.5×3500mm Autoclave
21-5021.3	Φ4.5×3000mm plasma
21-5022	Φ5×2500mm
21-5023	Φ5×3000mm
21-5023.1	Φ5×3000mm Autoclave
21-5023.3	Φ4.5×3000mm plasma
21-5023.5	Φ5×3000mm plasma
21-5024	Φ5×3000mm OLYMPUS
21-5024.1	Φ5×3000mm OLYMPUS Autoclave
21-5024.2	Φ5×3000mm OLYMPUS plasma

ADAPTOR



MEDICAL INSTRUMENTS STERILIZING BOX

